

# High-speed data transfer Twisted pairs connectors



 **LEMO**<sup>®</sup>

## Precision modular connectors to suit your application

LEMO's Original Push-Pull connector range fulfils most specific & stringent requirements for many market segments, including but not limited to Test & Measurement, Industrial, Automotive, Semi-conductor, Medical, Aerospace & Defence. Constantly upgraded with the latest technologies since LEMO's invention of the Push-Pull connector (patented), it has been the trusted solution to build long lasting, safe and high precision interconnect solutions for more than 75 years. Its highly recognizable chocolate design pattern represents the LEMO brand and its outstanding reputation built over time for unrivalled quality and reliability.

LEMO's Original Push-Pull connector range is highly configurable and goes from ultra miniature to larger sizes, from low to high voltages, in electrical, fibre optics, fluidics or mixed configurations covering more than 90'000 combinations. It's the perfect all-rounder cost effective connector assortment built to last and protect any device it is connected to.

## LEMO's Push-Pull Self-Latching Connection System

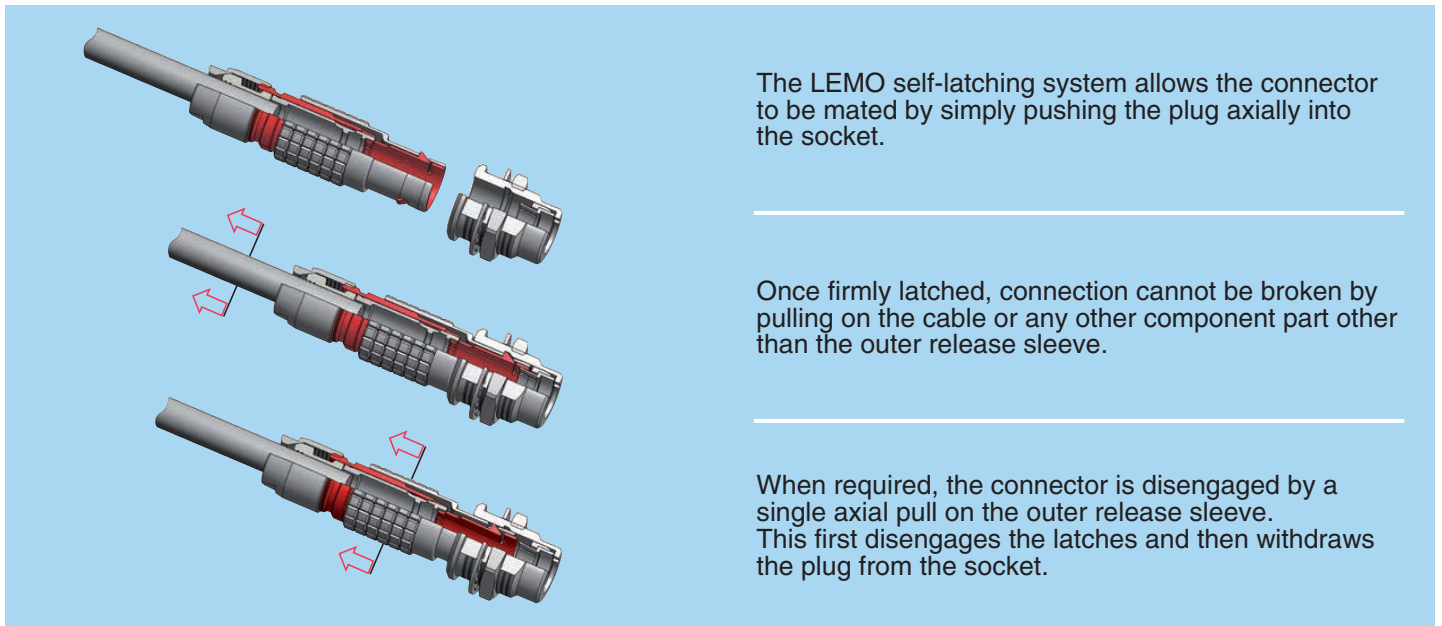

This self-latching system is renowned worldwide for its easy and quick mating and unmating features. It provides absolute security against vibration, shock or pull on the cable, and facilitates operation in a very limited space.



## UL Recognition

LEMO connectors are recognized by the Underwriters Laboratories (UL). The approval of the complete system (LEMO connector, cable and your equipment) will be easier because LEMO connectors are recognized.

## CE marking

CE marking  means that the appliance or equipment bearing it complies with the protection requirements of one or several European safety directives. CE marking  applies to complete products or equipment, **but not to electromechanical components, such as connectors.**

## REACH and RoHS

LEMO connector specifications comply with the requirements of the RoHS directive (2011/65/EU) and REACH regulation (1907/2006/EU) of the European Parliament and latest amendments. These REACH and ROHS regulations specify the restrictions of the use of hazardous substances in LEMO products marketed in Europe.

### Product safety notice & disclaimers

Please read and follow all instructions specified on the last page or on our [website](#) carefully and consult all relevant national and international safety regulations for your application. Improper handling, cable assembly, or wrong use of connectors can result in hazardous situations.

LEMO products and services are provided "as is." LEMO makes no warranties or representations with regard to LEMO product & services or use of them, express, implied or statutory, including for accuracy, completeness, or security.

In no event shall LEMO be liable for any direct, indirect, punitive, incidental, special consequential damages, to property or life, whatsoever arising out of or connected with the use or misuse of LEMO's products.

## High-speed data transfer introduction

Equipped with more and more sensors, objects, vehicles and machines are more and more communicating with each other and with the outside world thanks to the emergence of the Internet of Things (IoT). The reliable transfer of more and more data in the shortest possible time is becoming increasingly important.

High-speed data transfer can be achieved with different cable technologies, mainly twisted pairs ①, coaxial ② and fibre optic ③ cables. Environmental conditions, distance, cost and application are key decision criteria to select the appropriate cable technology; twisted pairs being by far the most commonly used one.

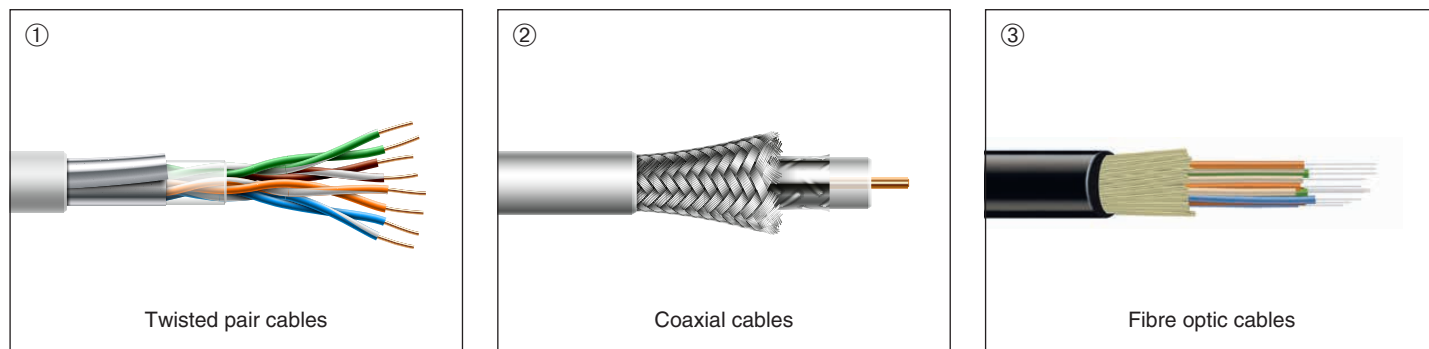

Data protocols such as Ethernet, USB, are providing the normative framework defining key parameters of the data transmission channel (e.g. Insertion Loss, Return Loss, Crosstalk, Noise). Specific limits to these parameters are defined for each element / component of a transmission line (connector, cable, cable lengths etc...). This ultimately ensures that, when parameters are respected, the transmission line can perform to its maximum specified data transfer speed (in Mb/s or Gb/s).

Over time connector designs have been standardized for each data transmission protocol (e.g. RJ45, USB 2.0 Type A, etc.). These standard connectors are widely used in many applications but are often not robust and durable enough when subjected to demanding conditions. LEMO recognized this gap and developed specific inserts matching the electrical parameters required by the various high-speed norms, while leveraging its high quality and environmental resistant optimized housing designs.





Over the years data transfer protocols have continually progressed in speed, security and quality to meet evolving network requirements. LEMO has been providing reliable high-speed proprietary connectors for twisted pairs since early 2000s complying with the various evolutions of both Ethernet and USB protocols. Many of these connectors are included in this catalogue, but LEMO is also providing custom high-speed solutions, combining high-speed data transfer with other signal or power requirements. LEMO also has a broad range of connectors for coaxial and fiber optics cables, though not included in this catalogue.







## Cable assembly High-speed

While connectors are playing a key role in securing data integrity and transfer speed, related cables also must comply to the same protocols, and last but not least cable assembly have to be properly executed. Interconnect solutions should then be tested and certified to guarantee full compliancy. LEMO is fully equipped to perform all these steps including performance testing and can thus provide full end to end solutions.



# LEMO High-speed data transfer connectors

USB 			
USB 3.1		USB 2.0	
	<b>542</b> 	<b>304</b> 	<b>U2A</b> 
Series	B, K, T	B, K, T, W	M
Sizes	2	0 & 1	L
Insert configuration	Proprietary interface	Proprietary interface	Type A
Maximum data transfer speed	10 Gb/s	480 Mb/s	
Contacts	2 SuperSpeed pairs	-	
	1 High speed pair	1 High speed pair	
	2 Low Voltage	2 Low Voltage	

Ethernet 					
10G Base-T4	1000 Base-T4		1000 Base-T1		
<b>514</b> 	<b>308</b> 	<b>514</b> 	<b>511 (SPE)</b> 	<b>512 (2x SPE)</b> 	
Series	B, K, T, W	B, T	M	B, T	
Sizes	2	1	2	0	1
IEEE standard	IEEE 802.3an	IEEE 802.3ab		IEEE 802.3bp	
Maximum data transfer speed	10 Gb/s	1 Gb/s		1 Gb/s	
Number of twisted pairs	4	4		1	2
Cable category	CAT 6A	CAT 5e	CAT 6	CAT 5e	

## Table of contents

<b>Technical characteristics</b> .....	4
<b>USB connectors</b> .....	5
<b>USB 3.1 (10 Gb/s)</b>	
<b>Proprietary interface (542)</b>	
Interconnections .....	5
Part Numbering system .....	6
Insert configuration .....	7
Recommended cables .....	8
PCB drilling pattern .....	8
<b>USB 2.0 (480 Mb/s)</b>	
<b>Proprietary interface (304)</b>	
Interconnections .....	9
Part Numbering system .....	10
Insert configuration .....	11
PCB drilling pattern .....	11
<b>Type A interface (U2A)</b>	
Interconnections .....	12
Part Numbering system .....	13
Insert configuration .....	13
<b>Ethernet connectors</b> .....	14
<b>Ethernet 10G Base-T4 (514)</b>	
Interconnections .....	14
Part Numbering system .....	16
Insert configuration .....	17
PCB drilling pattern .....	19
<b>Ethernet 1000 Base-T4 (308)</b>	
Interconnections .....	20
Part Numbering system .....	21
Insert configuration .....	22
PCB drilling pattern .....	22
<b>Ethernet 1000 Base-T4 (514)</b>	
Interconnections .....	23
Part Numbering system .....	24
Insert configuration .....	24
PCB drilling pattern .....	26
<b>Ethernet 1000 Base-T1 (511 / 512)</b>	
Interconnections .....	27
Part Numbering system .....	28
Insert configuration .....	29
PCB drilling pattern .....	32
<b>Product safety notice</b> .....	33

## Technical characteristics

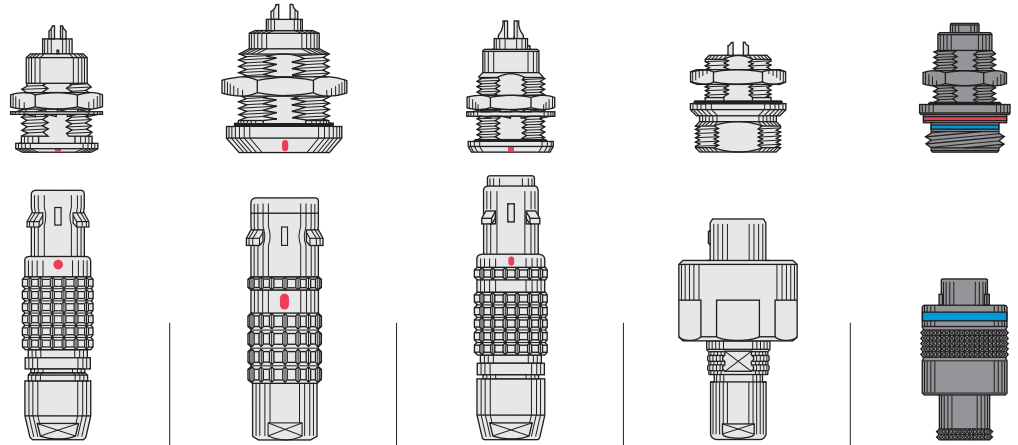

Series	B			K			T			W			M	
Sizes	0	1	2	0	1	2	0	1	2	0	1	2	2	L
Plug ø (mm)	9.5	12.0	15.0	11.0	13.0	16.0	9.5	12.0	15.0	17.2	19.3	23.5	18.9	29.4
Socket ø (mm)	12.5	16.0	20.0	18.0	20.0	25.0	12.0	16.0	20.0	16.2	19.5	22.5	17.2	28.0
Shell material	Stainless steel or brass											Aluminium or brass		
Shell plating	Chrome or black chrome						Chrome			Antracite nickel or chrome				
Insulator material	PEEK / FEP													
Male contact material	Brass (UNS C 34500 or 38500)													
Female contact material	Bronze (UNS C 54400) or Cu-Be (Fs QQ-C-530)													
Locking mechanism	Push-Pull						Screw locking			Ratchet 3/4 turn locking				
Mating cycles	> 5000			> 3000			> 1000			> 3000				
Operating temperatures (Standard)	-55°C to 250°C			-55°C to 200°C			-20°C to 200°C			-55°C to 200°C				
Operating temperature (Watertight or vacuumtight)	-20°C to 80°C											-20°C to 80°C		
Ingress protection (mated)	IP50 (vacuum. socket avail.)			IP66 to IP68			IP68 30 bars			IP68				
Environment	Indoor			Outdoor or harsh environment										

## Electrical performance

Characteristics	B Series	K Series	T Series	W Series	M Series
Data protocols / Standard	USB 2.0 / USB 3.1 / Eth Cat6a / SPE				USB 2.0 / Eth Cat6
Test voltage / Rated current	See tables pages 7, 11, 13, 17, 22, 24 and 29				

**Note:** to take advantage of the increased bandwidth the data protocols provide, all components must be compatible with the respective data protocol. The bandwidth performance is determined by the lowest rated component, i.e. wiring an Ethernet 10000 Base T4 connector to a CAT 5 cable will only provide a data speed of 1 Gb/s.

For more detailed technical characteristics, please contact LEMO or refer to the following catalogues:

- [https://www.lemo.com/catalog/ROW/UK\\_English/unipole\\_multipole.pdf](https://www.lemo.com/catalog/ROW/UK_English/unipole_multipole.pdf)
- [https://www.lemo.com/catalog/ROW/UK\\_English/T\\_series\\_en.pdf](https://www.lemo.com/catalog/ROW/UK_English/T_series_en.pdf)
- [https://www.lemo.com/catalog/ROW/UK\\_English/W\\_series\\_en.pdf](https://www.lemo.com/catalog/ROW/UK_English/W_series_en.pdf)
- [https://www.lemo.com/catalog/ROW/UK\\_English/M\\_series.pdf](https://www.lemo.com/catalog/ROW/UK_English/M_series.pdf)

# High-speed USB 3.1 (10 Gb/s)

(542)



LEMO's USB 3.1 connectors are meeting the stringent requirements of the USB protocol for High-speed data transfer up to 10 Gb/s. These products are specifically designed to work in demanding environments (e.g. extreme temperature, high humidity, vibration) for applications such as industry, food processing, industrial automation, technical equipment in buildings, data communication, defence and instrumentation.

While using a proprietary interface guaranteeing high quality signal within a very robust casing, the LEMO connectors can be used in conjunction with standard USB type interfaces (e.g. Type-C) in a cable assembly.

This new USB 3.1 contact configuration can be built into various LEMO product lines with metal housing, including B Series, K Series and T Series.

## 2B Series models

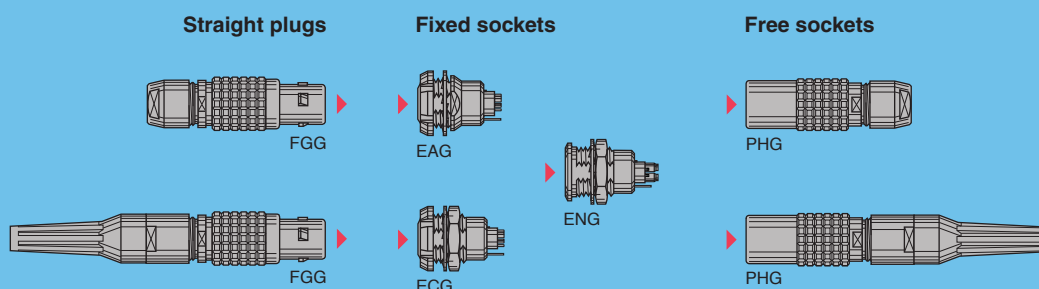

## 2K Series models

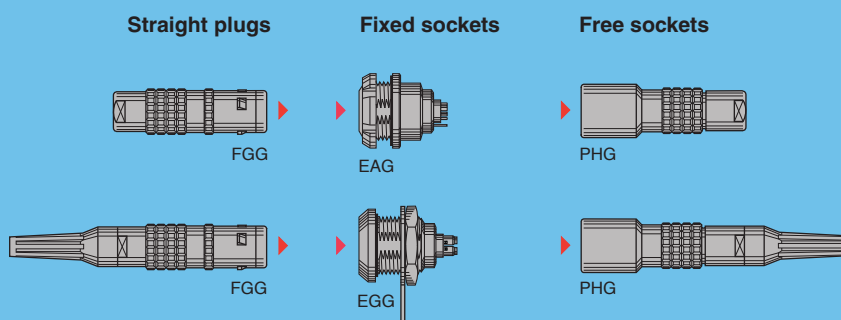

## 2T Series models

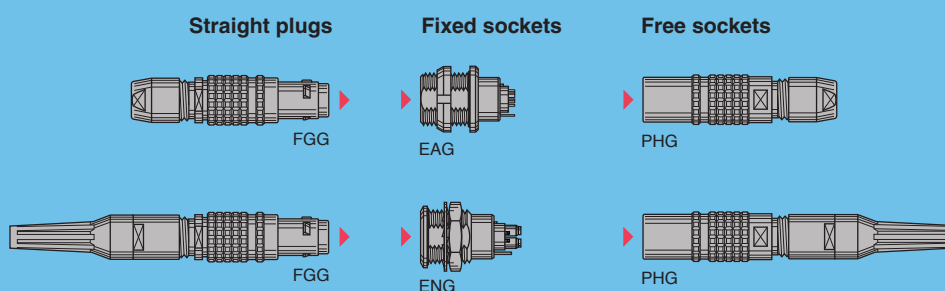

## Model Description

- EAG** Fixed socket with earthing tag, nut fixing, key (G) (back panel mounting)
- ECG** Fixed socket with two nuts, key (G) (back panel mounting)
- EGG** Fixed socket with earthing washer, nut fixing, key (G)

- ENG** Fixed socket with earthing tag, nut fixing, key (G)
- FGG** Straight plug, key (G), cable collet
- FGG** Straight plug, key (G), cable collet and nut for fitting a bend relief
- PHG** Free socket, key (G), cable collet

- PHG** Free socket, key (G), cable collet and nut for fitting a bend relief

**Note:** for others models please reach out to LEMO. Print contact are highly recommended to limit risk of signal deterioration. See Unipole-Multipole and T series catalogues for connectors dimensions.

## Part Numbering System (e.g. 2T series)

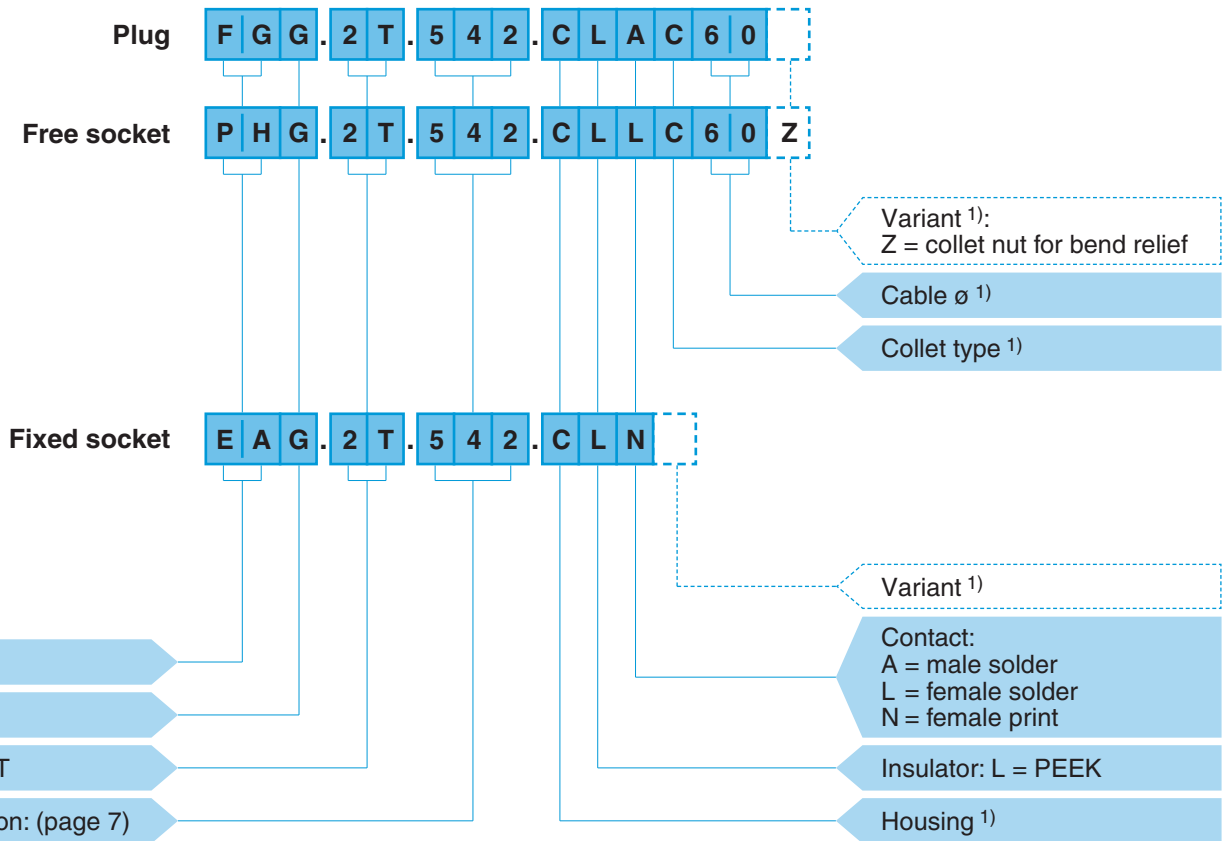

**FGG.2T.542.CLAC60** = straight plug with key (G) and cable collet, 2T Series, USB 3.1 type, outer shell in chrome-plated brass, PEEK insulator, male solder contacts, C type collet for 6.0 mm diameter cable.

**PHG.2T.542.CLLC60Z** = free socket with key (G) and cable collet, 2T Series, USB 3.1 type, outer shell in chrome-plated brass, PEEK insulator, female solder contacts, C type collet for 6.0 mm diameter cable and nut for fitting a bend relief.

**EAG.2T.542.CLN** = fixed socket, nut fixing, with key (G), 2T Series, USB 3.1 type, outer shell in chrome-plated brass, PEEK insulator, female print contacts.



**Note:** <sup>1)</sup> see Unipole-Multipole and T series catalogues for alternatives.



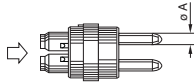
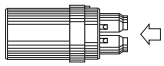

## Insert configuration

### USB 3.1

Male solder contacts 	Female solder contacts 	Reference	Series	A ø (mm)	AWG		Solder	Print	Test voltage (kV DC) <sup>1)</sup> Contact-contact	Test voltage (kV DC) <sup>2)</sup> Contact-shell	Rated current (A) <sup>1) 3)</sup>
					Solder (max.)						
		542	2B-2K-2T	0.5	22	●	●	0.35	0.7	5	

**Note:** USB 3.1 insulators can be built into the 2B, 2K and 2T (IP68) Series.

- 1) see calculation method, caution and suggested standard on unipole-multipole catalogue.
- 2) test voltage (kV) contact-shell is slightly lower for T series (values here are for B series).
- 3) rated current for contacts 1 & 2.

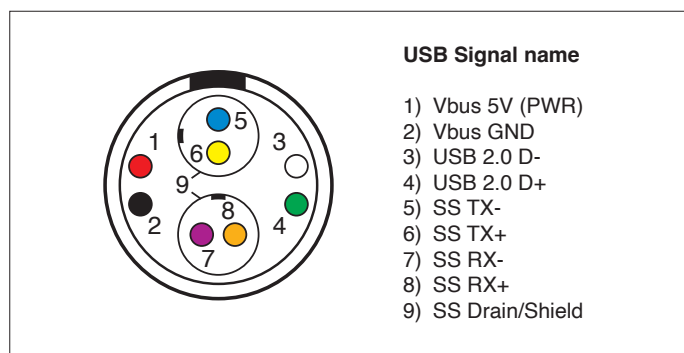

## Compliance and signal quality of USB 3.1 LEMO connectors

The eye diagram generated by the superposition of several traces of the signal allows to quickly:

- Validate signal quality
- Measure noise and distortion (eye opening)
- And synchronization efficiency

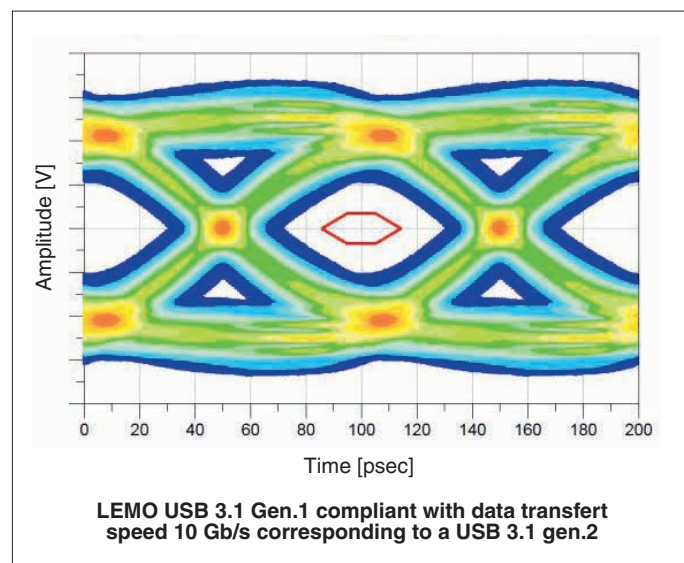
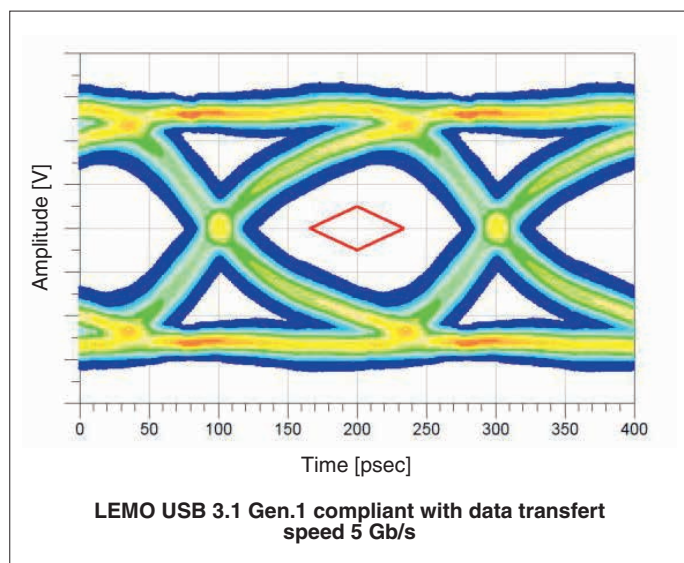

## Cable construction and recommended cable

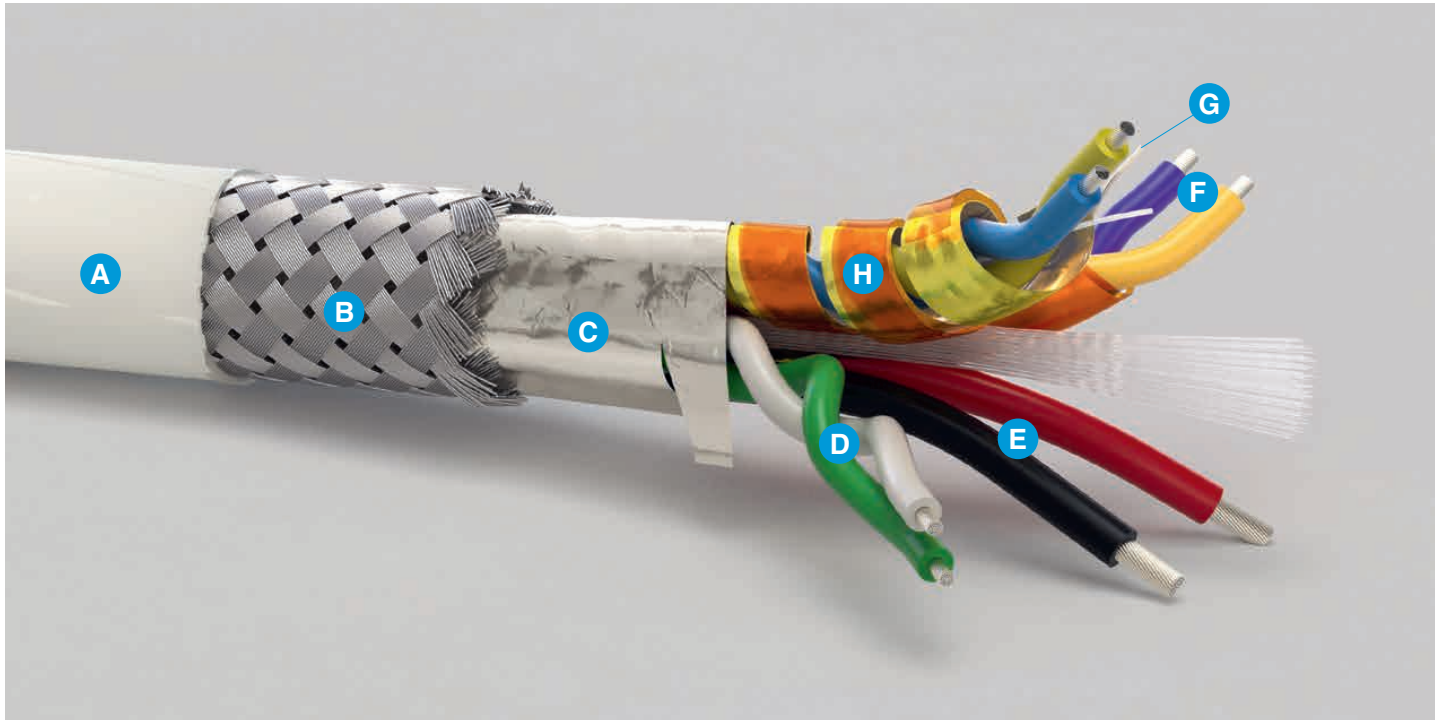

**A:** Jacket  
**B:** Braided shield  
**C:** Cable foil shield

**D:** High-speed wires (2x)  
**E:** Low voltage wires (PWR + GND)  
**F:** SuperSpeed wires (4x)

**G:** Drain wire (2x)  
**H:** SuperSpeed wires foil shield (mandatory)

### Recommended USB cable: PIC USB3-2624 (PTFE jacket) of PIC Wire & Cable

The LEMO proprietary interface is compliant with the Universal Serial Bus specification 3.1 and can be used for 10 Gb/s applications with cables up to 1.5 m.

To take advantage of the increased bandwidth the data protocols provide; all components must be compatible with the respective data protocol. The bandwidth performance is determined by the lowest rated component, i.e. wiring a USB 3.1 connector to a USB 2.0 cable will only give USB 2.0 speeds.

Connector assembly and installation should only be carried out by properly trained personnel. Proper tools must be used during installation and / or assembly in order to obtain safe and reliable performance. LEMO is specialized in cable assemblies and is available to provide wired and certified solutions. Please don't hesitate to contact us for quotes.

## PCB drilling pattern

### Fixed socket with straight print contact

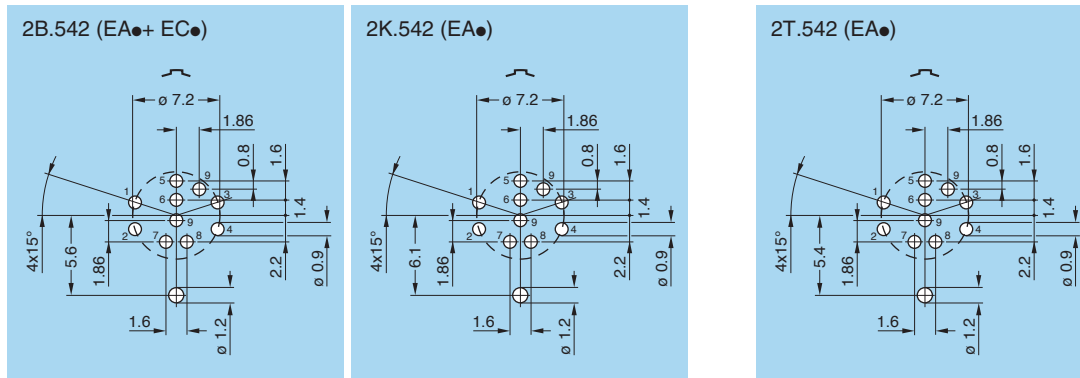

**Note:** contact numbering is for female contact version only.

# High-speed USB 2.0 (480 Mb/s)

(304)



Each protocol requires a specific design rules for the connector. For instance, the LEMO connectors have a specific insert configurations that deliver USB 2.0 speeds (up to 480 Mb/s). The proprietary 4 pins interface allow to reduce the size of the physical connector while delivering the data speed demanded by several markets.

## 0B-1B Series models

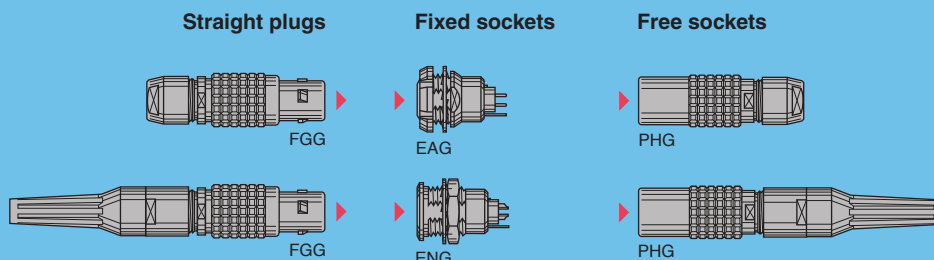

## 0K-1K Series models



## 0T-1T Series models

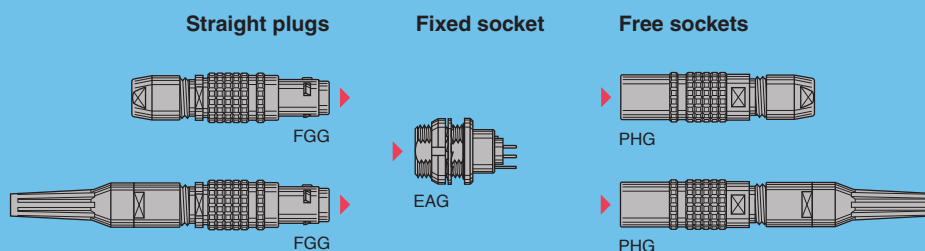

## 0W-1W Series models

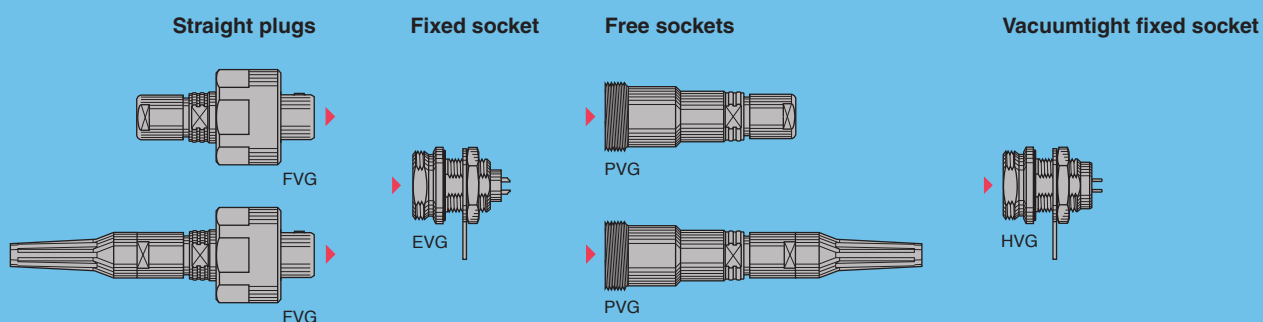

## Model Description

- EAG** Fixed socket with earthing tag, nut fixing, key (G) (back panel mounting)
- ENG** Fixed socket with earthing tag, nut fixing, key (G)
- EVG** Fixed socket with earthing washer, nut fixing, key (G)
- FGG** Straight plug, key (G), cable collet

- FGG** Straight plug, key (G), cable collet and nut for fitting a bend relief
- FVG** Straight plug, key (G), cable collet
- FVG** Straight plug, key (G), cable collet and nut for fitting a bend relief
- HVG** Fixed socket with earthing washer, nut fixing, key (G), vacuumtight

- PHG** Free socket, key (G), cable collet
- PHG** Free socket, key (G), cable collet and nut for fitting a bend relief
- PVG** Free socket, key (G), cable collet
- PVG** Free socket, key (G), cable collet and nut for fitting a bend relief

**Note:** for others models please reach out to LEMO. Print contact are highly recommended to limit risk of signal deterioration. See Unipole-Multipole, T series and W series catalogues for connectors dimensions.

## Part Numbering System (e.g. 0T series)

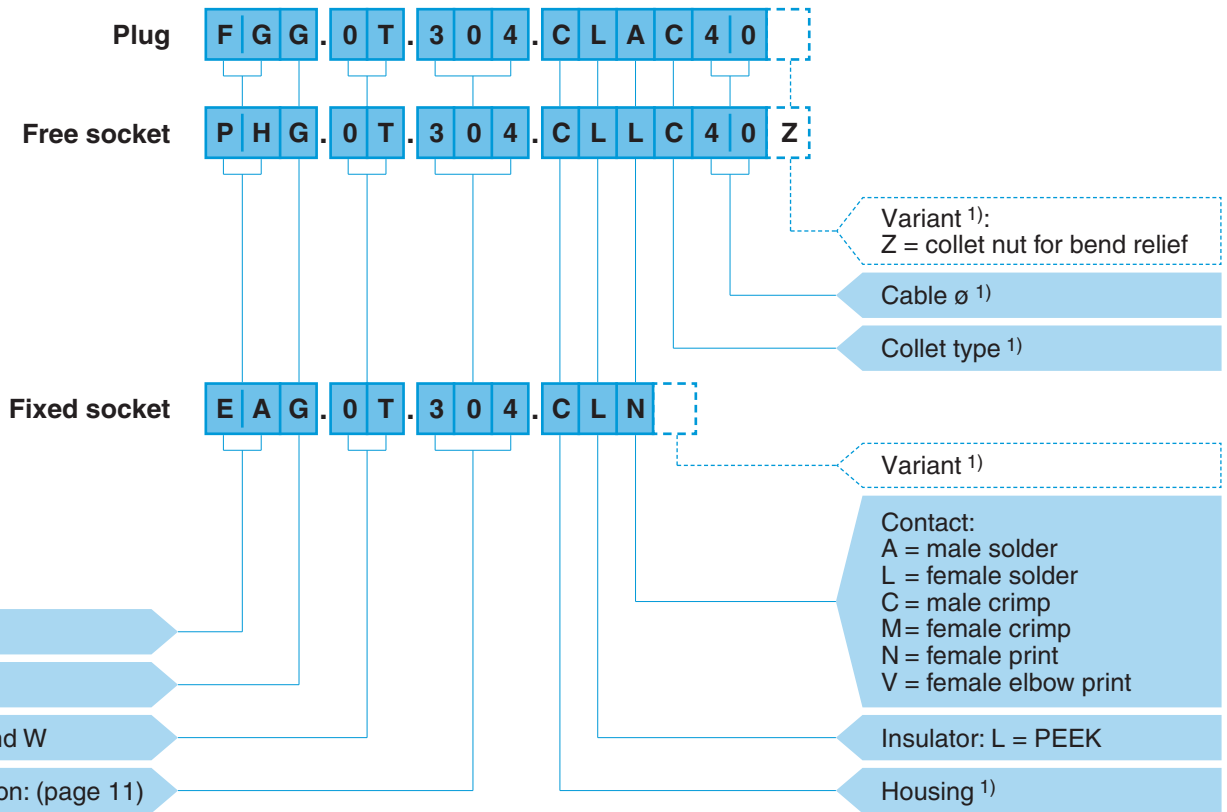

**FGG.0T.304.CLAC40** = straight plug with key (G) and cable collet, 0T Series, USB 2.0 type, outer shell in chrome-plated brass, PEEK insulator, male solder contacts, C type collet for 4.0 mm diameter cable.

**PHG.0T.304.CLLC40Z** = free socket with key (G) and cable collet, 0T Series, USB 2.0 type, outer shell in chrome-plated brass, PEEK insulator, female solder contacts, C type collet for 4.0 mm diameter cable and nut for fitting a bend relief.

**EAG.0T.304.CLN** = fixed socket, nut fixing, with key (G), 0T Series, USB 2.0 type, outer shell in chrome-plated brass, PEEK insulator, female print contacts.

**Note:** <sup>1)</sup> see Unipole-Multipole, T series and W series catalogues for alternatives.



## Insert configuration

### USB 2.0

Solder contacts	Crimp contacts	Reference	Series	Contact $\phi$ (mm)	Contact type				AWG			Solder contact		Crimp contact		Rated current (A) <sup>1)</sup>
					Solder	Crimp	Print (straight)	Print (elbow)	Solder (max.)	Crimp		Test voltage (kV DC) <sup>1)</sup> Contact-contact	Test voltage (kV DC) <sup>2)</sup> Contact-shell	Test voltage (kV DC) <sup>1)</sup> Contact-contact	Test voltage (kV DC) <sup>2)</sup> Contact-shell	
										min.	max.					
		304	0B-0K 0T-0W	0.7	●	●	●	●	22	32	22	0.60	0.49	0.95	0.78	7.0
			1B-1K 1T-1W	0.9	●	●	●	●	22	32	20	0.95	1.02	1.20	1.27	10.0

**Note:**

- 1) see calculation method, caution and suggested standard on unipole-multipole catalogue.
- 2) test voltage (kV) contact-shell is slightly lower for T series (values here are for B series).

## PCB drilling pattern

### Fixed socket with straight print contact

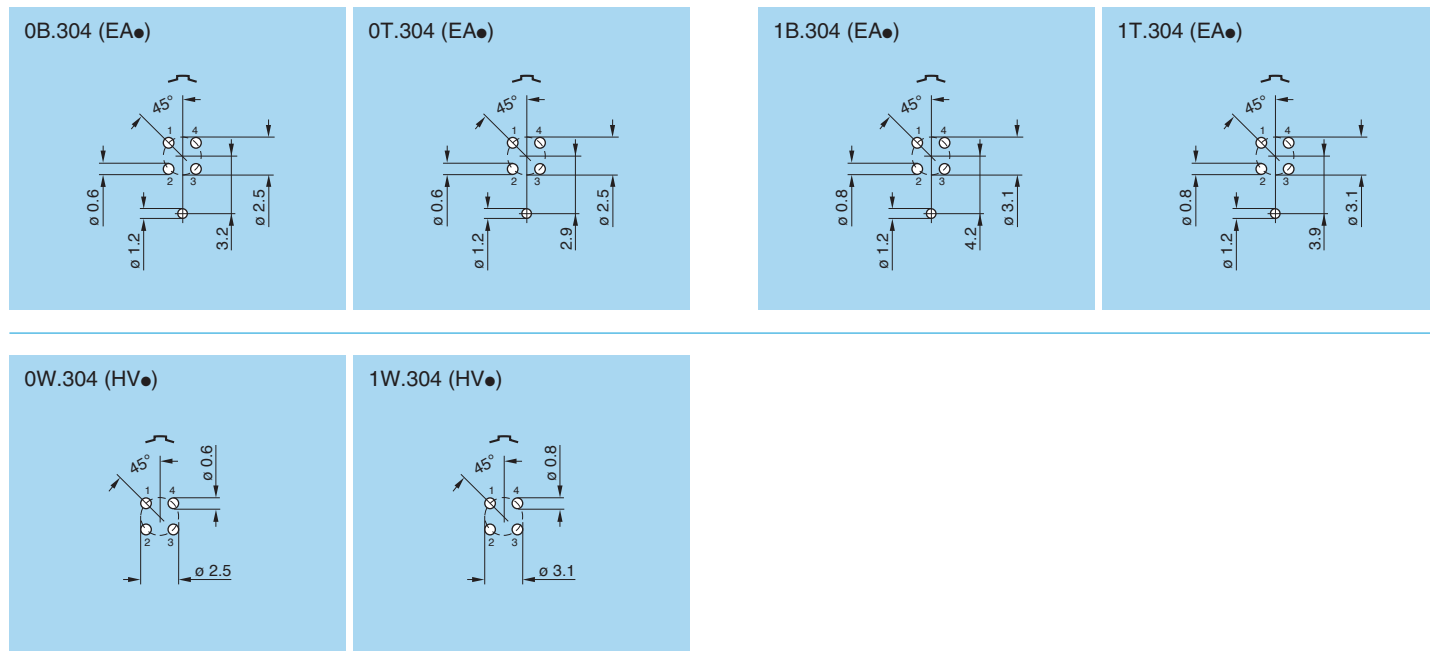

**Note:** contact numbering is for female contact version only.

# High-speed USB 2.0 (480 Mb/s)

(U2A)



A USB type A connector encapsulated into a ratchet coupling M series product offers a robust solution for harsh environments meeting the IP68 rating when mated.

This connector is designed for outdoor utilization in Defense, Oil & Gas or Automotive industries to name a few, essential applications requiring a standard USB interface in a protective casing. The complete product line includes straight plugs, panel mounted sockets and watertight caps.

## LM Series models

### Straight plugs

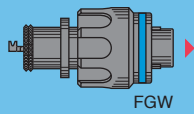
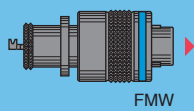

### Fixed sockets

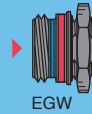
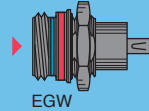

## Model Description

**EGW** Fixed socket, female to female, nut fixing, key (W)

**EGW** Fixed socket, nut fixing, key (W)

**FMW** Straight plug, key (W) with knurled grip and mold stop

**FGW** Straight plug, key (W) with arctic grip and mold stop

**Note:** for others models please reach out to LEMO. Print contact are highly recommended to limit risk of signal deterioration. See M series catalogue for connectors dimensions.

## Part Numbering System (LM series)

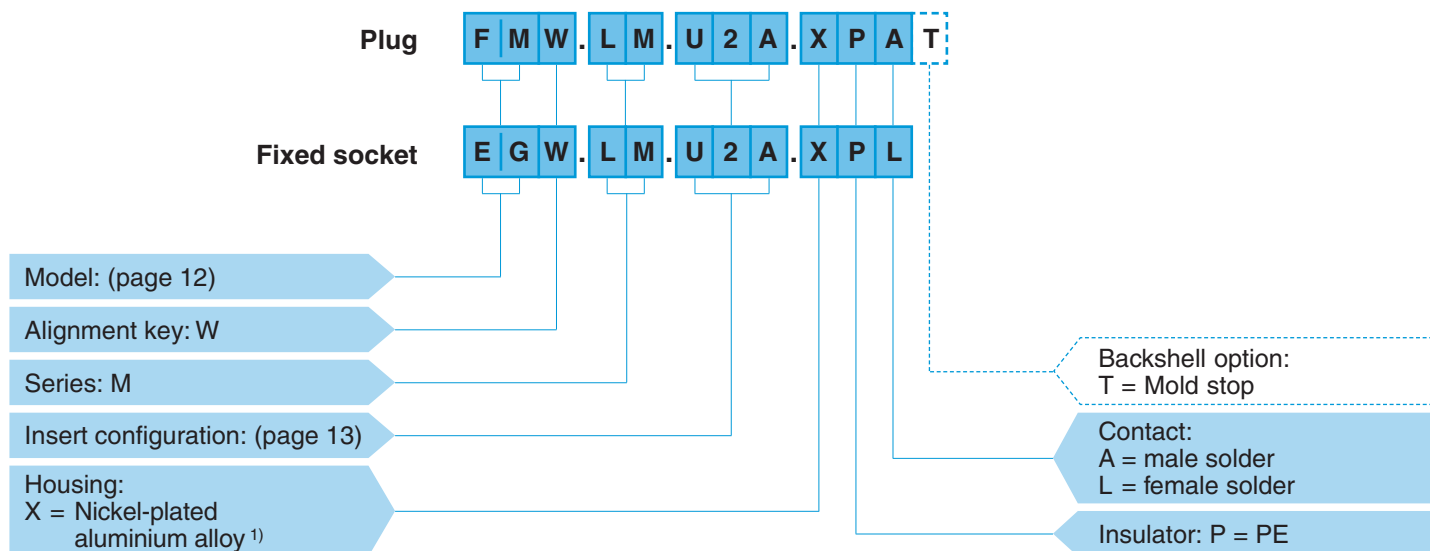

**FMW.LM.U2A.XPAT** = straight plug with key (W), LM series, USB 2.0 type, outer shell in anthracite nickel-plated aluminium alloy, male insert, with knurled grip and mold stop.

**FGW.LM.U2A.XPAT** = straight plug with key (W), LM series, USB 2.0 type, outer shell in anthracite nickel-plated aluminium alloy, male insert, with arctic grip and mold stop.

**EGW.LM.U2A.XPP** = fixed socket, nut fixing, with key (W), LM series, USB 2.0 type, outer shell in anthracite nickel-plated aluminium alloy, female to female insert.

**EGW.LM.U2A.XPL** = fixed socket, nut fixing, with key (W), LM series, USB 2.0 type, outer shell in anthracite nickel-plated aluminium alloy, female insert.

**Note:** <sup>1)</sup> anthracite colour / 48 hours salt fog resistance.



## USB 2.0

Male insert front view	Female insert front view	Reference	Series	Number of contacts	Solder contact	Test voltage (kV DC) <sup>1)</sup> Contact-contact	Test voltage (kV DC) <sup>1)</sup> Contact-shell	Rated current (A)
		<b>U2A</b>	LM	4	●	0.85	0.67	n.a.

**Note:** <sup>1)</sup> test voltage according to IEC 60512-2 test 4a. Altitude correction factor is given in IEC 60664-1 table A.2.



The Ethernet 10G Base-T4 protocol (IEEE 802.3an standard), allows High-speed data traffic over 4 pairs cable harnesses up to 10 Gb/s.

## 2B Series models

### Straight plugs

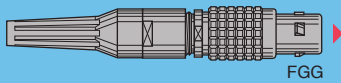
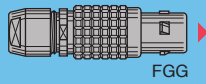

### Fixed sockets

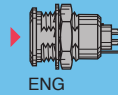
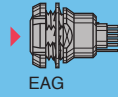

### Elbow socket

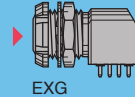

### Free sockets

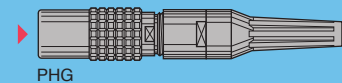
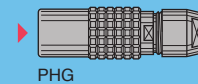

### Elbow plugs

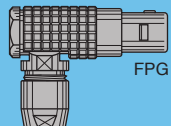
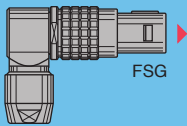

### Watertight or vacuumtight fixed sockets

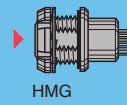
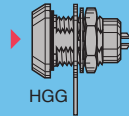

## 2K Series models

### Straight plugs

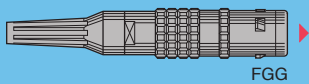
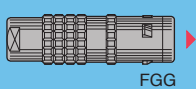

### Fixed sockets

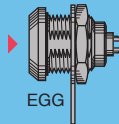
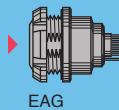

### Free sockets

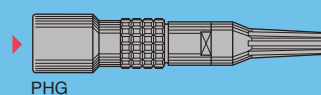
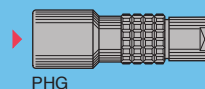

### Fixed sockets

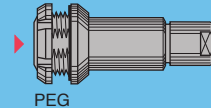
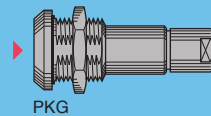

### Elbow plug

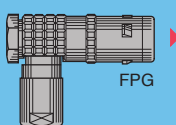

### Watertight or vacuumtight fixed socket

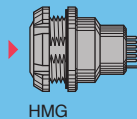

## Model Description

- EAG** Fixed socket with earthing tag, nut fixing, key (G) (back panel mounting)
- EGG** Fixed socket with earthing washer, nut fixing, key (G)
- ENG** Fixed socket with earthing tag, nut fixing, key (G)
- EXG** Elbow (90°) socket for printed circuit with two nuts, key (G)
- FGG** Straight plug, key (G), cable collet
- FGG** Straight plug, key (G), cable collet and nut for fitting a bend relief

- FPG** Elbow (90°) plug, key (G), cable collet
- FSG** Anglissimo right angle plug, key (G), cable collet
- HGG** Fixed socket with earthing washer, nut fixing, key (G), watertight or vacuumtight
- HMG** Fixed socket with earthing tag, nut fixing, key (G), watertight or vacuumtight
- PEG** Fixed socket, nut fixing, key (G), cable collet (back panel mounting)
- PHG** Free socket, key (G), cable collet

- PHG** Free socket, key (G), cable collet and nut for fitting a bend relief
- PKG** Fixed socket, nut fixing, key (G), cable collet

**Note:** for others models please reach out to LEMO. Print contact are highly recommended to limit risk of signal deterioration. See Unipole-Multipole catalogue for connectors dimensions.



# Ethernet 10G Base-T4

(514)



The Ethernet 10G Base-T4 protocol (IEEE 802.3an standard), allows High-speed data traffic over 4 pairs cable harnesses up to 10 Gb/s.

## 2T Series models

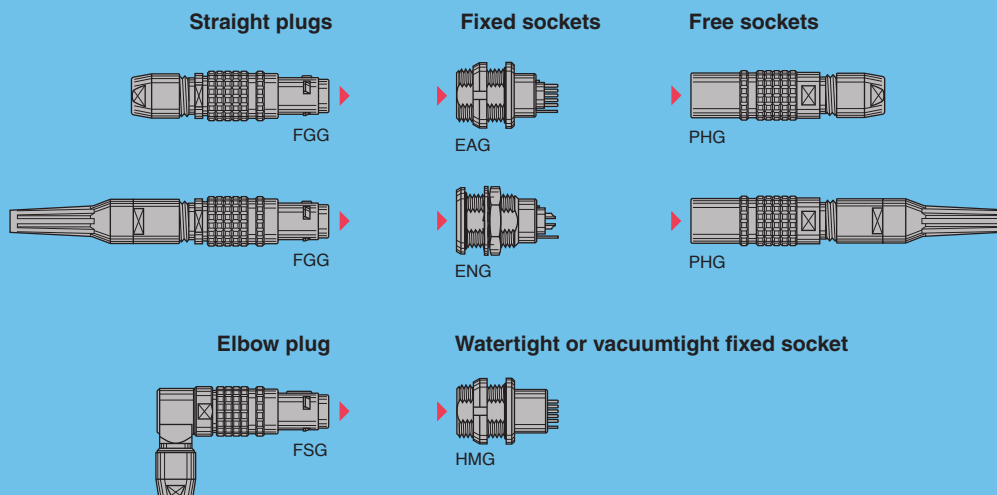

## 2W Series models

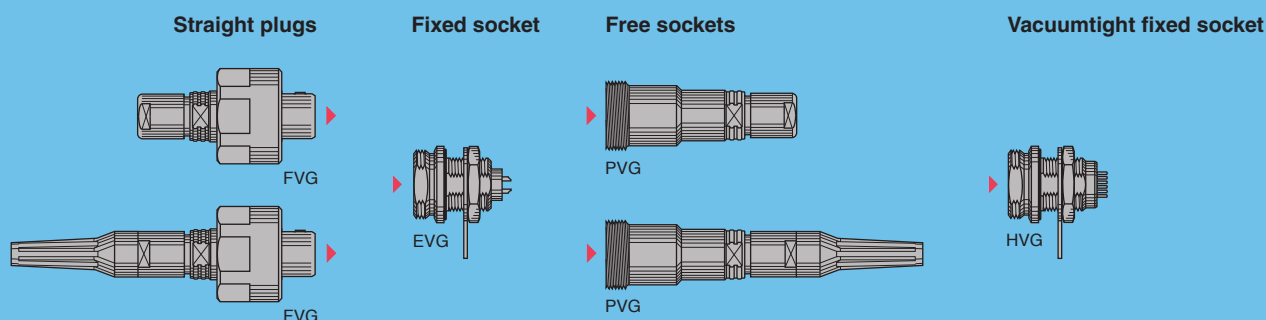

## Model Description

- EAG** Fixed socket with earthing tag, nut fixing, key (G) (back panel mounting)
- ENG** Fixed socket with earthing tag, nut fixing, key (G)
- EVG** Fixed socket with earthing washer, nut fixing, key (G)
- FGG** Straight plug, key (G), cable collet
- FGG** Straight plug, key (G), cable collet and nut for fitting a bend relief

- FSG** Anglissimo right angle plug, key (G), cable collet
- FVG** Straight plug, key (G), cable collet
- FVG** Straight plug, key (G), cable collet and nut for fitting a bend relief
- HMG** Fixed socket with earthing tag, nut fixing, key (G), watertight or vacuumtight
- HVG** Fixed socket with earthing washer, nut fixing, key (G), vacuumtight

- PHG** Free socket, key (G), cable collet
- PHG** Free socket, key (G), cable collet and nut for fitting a bend relief
- PVG** Free socket, key (G), cable collet
- PVG** Free socket, key (G), cable collet and nut for fitting a bend relief

**Note:** for others models please reach out to LEMO. Print contact are highly recommended to limit risk of signal deterioration. See T series and W series catalogues for connectors dimensions.

## Part Numbering System (e.g. 2T series)

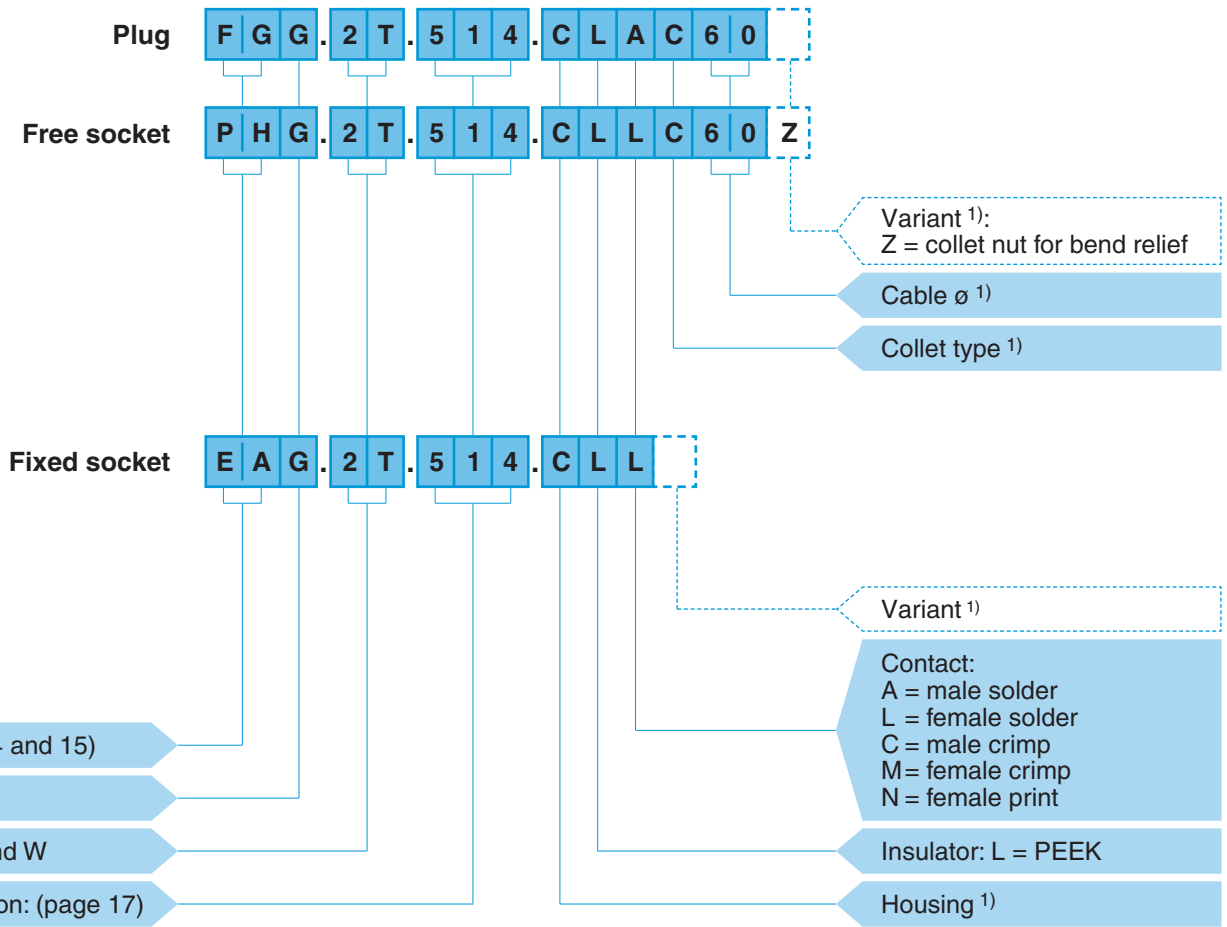

**FGG.2T.514.CLAC60** = straight plug with key (G) and cable collet, 2T Series, Ethernet type, outer shell in chrome-plated brass, PEEK insulator, male solder contacts, C type collet for 6.0 mm diameter cable.

**PHG.2T.514.CLLC60Z** = free socket with key (G) and cable collet, 2T Series, Ethernet type, outer shell in chrome-plated brass, PEEK insulator, female solder contacts, C type collet for 6.0 mm diameter cable and nut for fitting a bend relief.

**EAG.2T.514.CLL** = fixed socket, nut fixing, with key (G), 2T Series, Ethernet type, outer shell in chrome-plated brass, PEEK insulator, female solder contacts.

**Note:** <sup>1)</sup> see T series and W series catalogues for alternatives.



## Insert configuration

### Ethernet

Male crimp contacts	Female crimp contacts	Reference	Series	Number of contacts	Contact $\phi$ (mm)	Solder	Crimp	Print	Test voltage (kV DC) <sup>1)</sup> Contact-contact	Test voltage (kV DC) <sup>2)</sup> Contact-shell	Rated current (A) <sup>1)</sup>
		514	2B-2K 2T-2W	8	0.7	●	●	●	1.13	1.06	5

**Note:** <sup>1)</sup> see calculation method, caution and suggested standard on unipole-multipole catalogue.  
<sup>2)</sup> test voltage (kV) contact-shell is slightly lower for T series (values here are for B series).

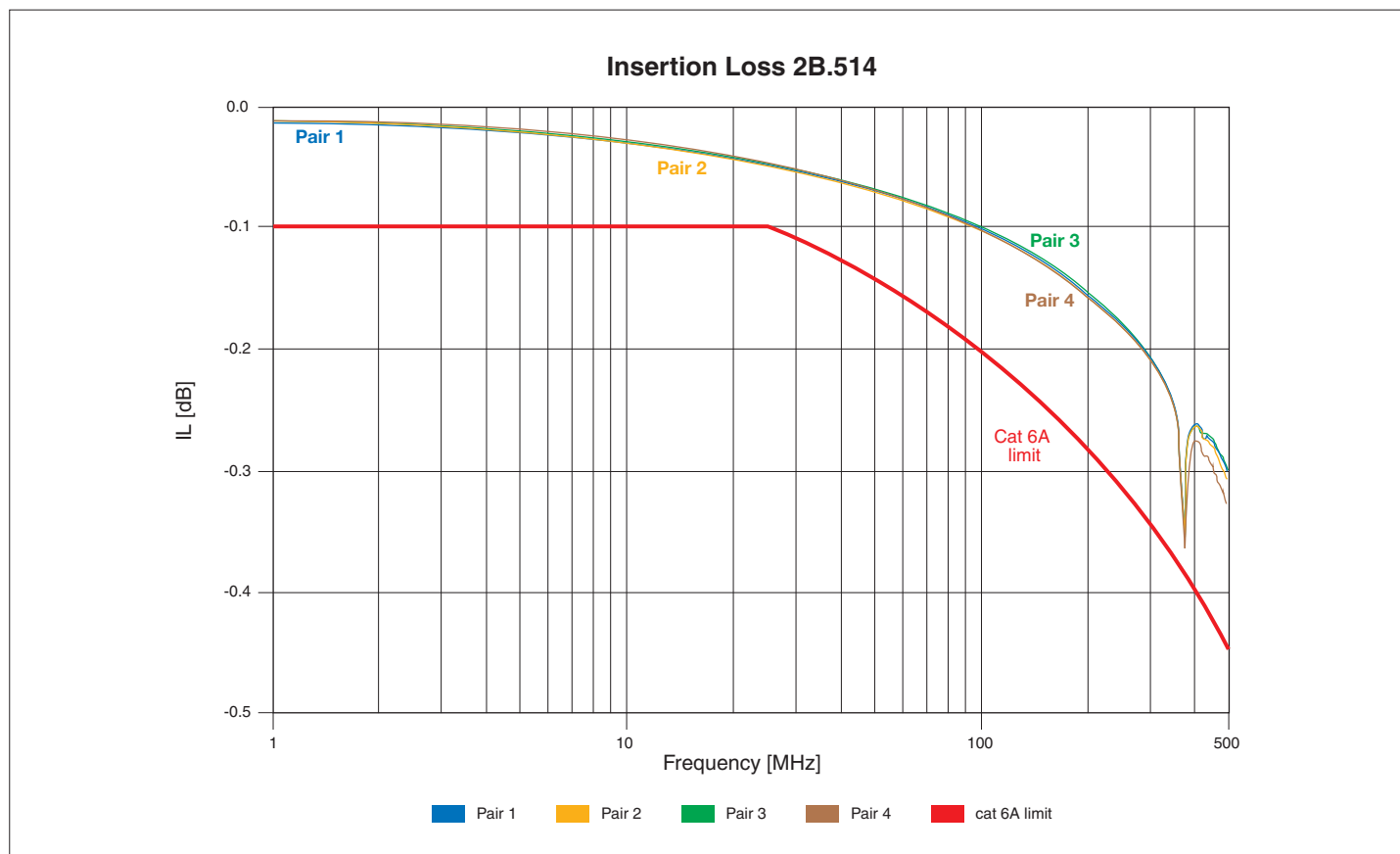

### Return Loss 2B.514

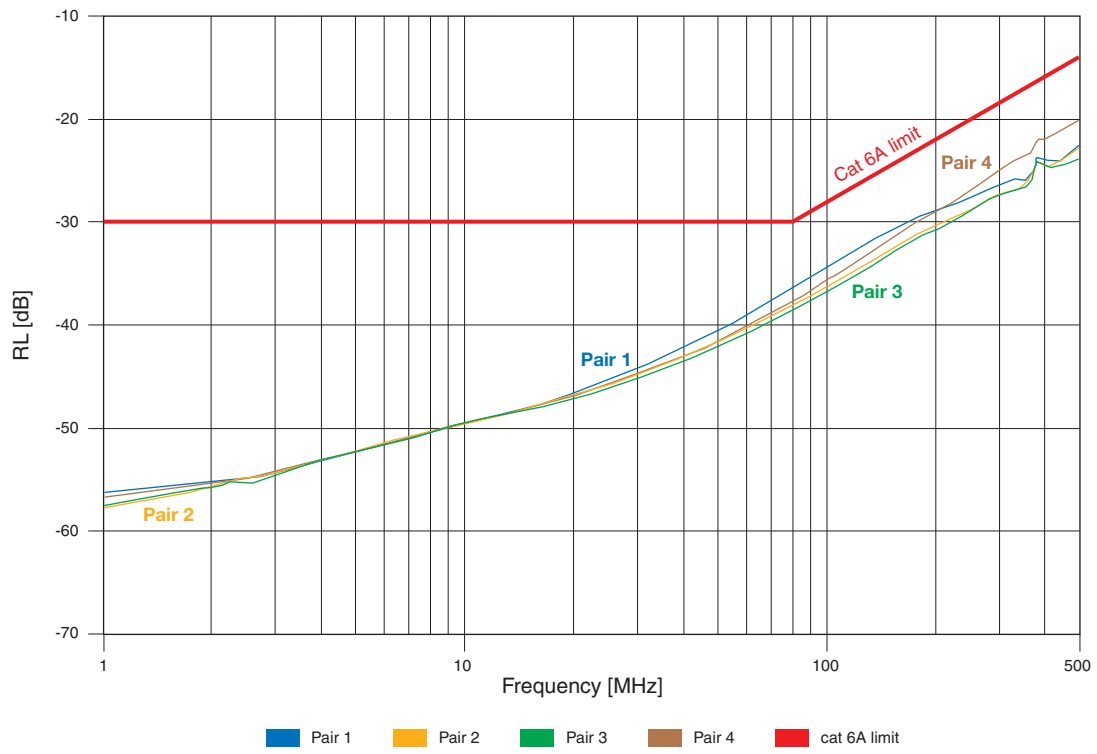

### Power Sum Next (PS NEXT) 2B.514

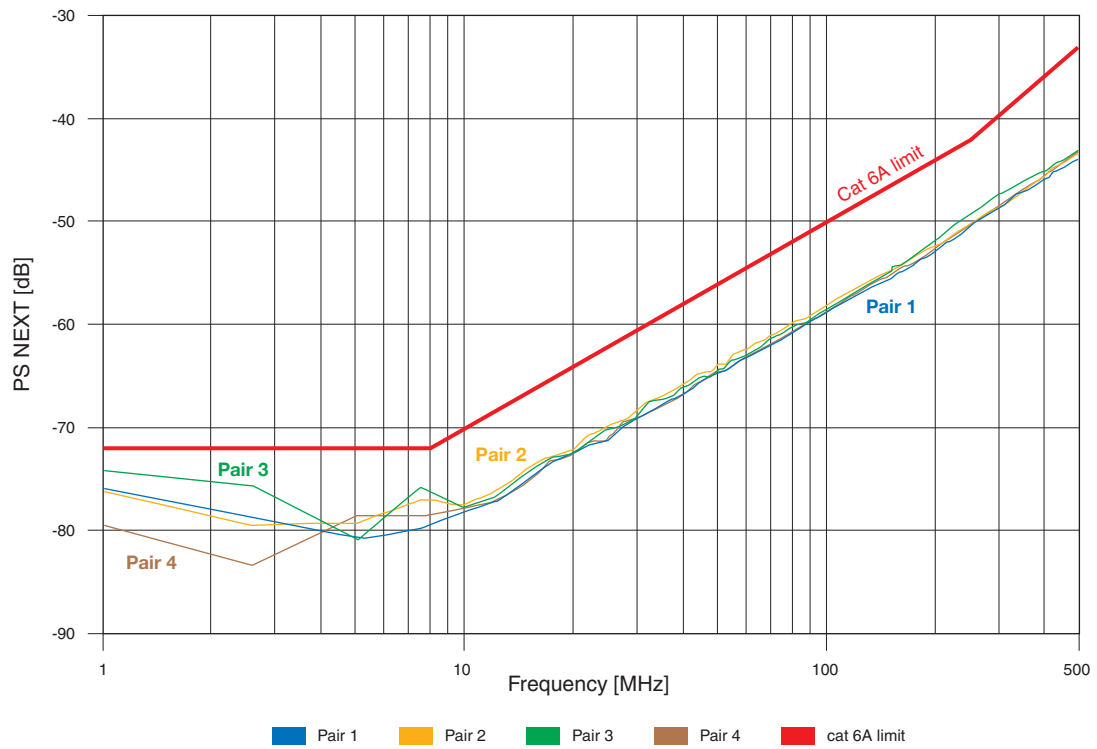

# PCB drilling pattern

## Fixed socket with straight print contact

2B.514 (EA●+ HM●)

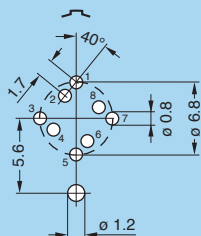

2K.514 (EA●+ HM●)

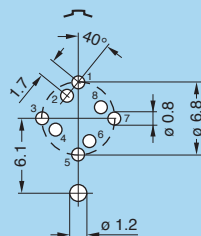

2T.514 (EA●+ HM●)

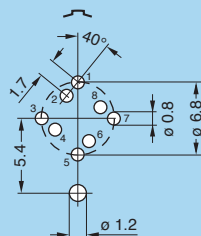

2W.514 (HV●)

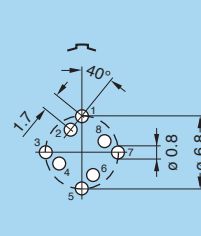

**Note:** contact numbering is for female contact version only.

## Elbow socket (90°) for printed circuit

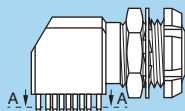

EX●.2B.514 (solder mount)

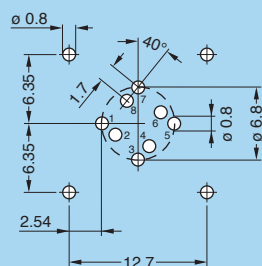

EX●. 2B.514 (screw mount)  
(harpoon)

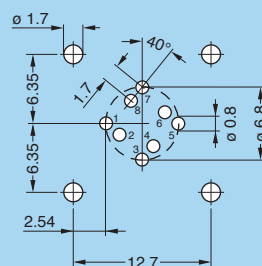

**Note:** contact numbering is for female contact version only.

# Ethernet 1000 Base-T4

(308)



Push-Pull Ethernet 1000 Base-T4 connectors (protocol IEEE 802.3ab) enable High-speed data traffic over 4 wire pairs cable harnesses up to 1 Gb/s. They are designed to operate with CAT 5e cables. Each of the four pairs supports an effective data rate of 250 Mb/s in each direction simultaneously. In addition to the well-known latching system, the proprietary interface makes them safer and lasting longer mating cycles.

## 1B Series models

### Straight plugs

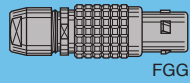

### Fixed sockets



### Free sockets

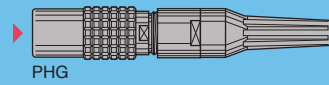
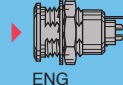
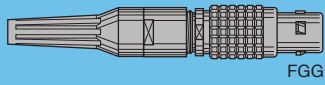
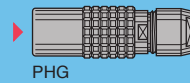

## 1T Series models

### Straight plugs

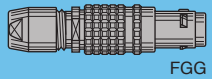

### Fixed socket

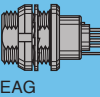

### Free sockets

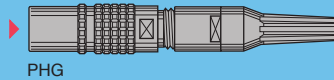
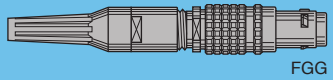
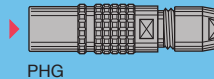

## Model Description

**EAG** Fixed socket with earthing tag, nut fixing, key (G) (back panel mounting)  
**ENG** Fixed socket with earthing tag, nut fixing, key (G)

**FGG** Straight plug, key (G), cable collet  
**FGG** Straight plug, key (G), cable collet and nut for fitting a bend relief

**PHG** Free socket, key (G), cable collet  
**PHG** Free socket, key (G), cable collet and nut for fitting a bend relief

**Note:** for others models please reach out to LEMO. Print contact are highly recommended to limit risk of signal deterioration. See Unipole-Multipole and T series catalogues for connectors dimensions.

## Part Numbering System (e.g. 1T series)

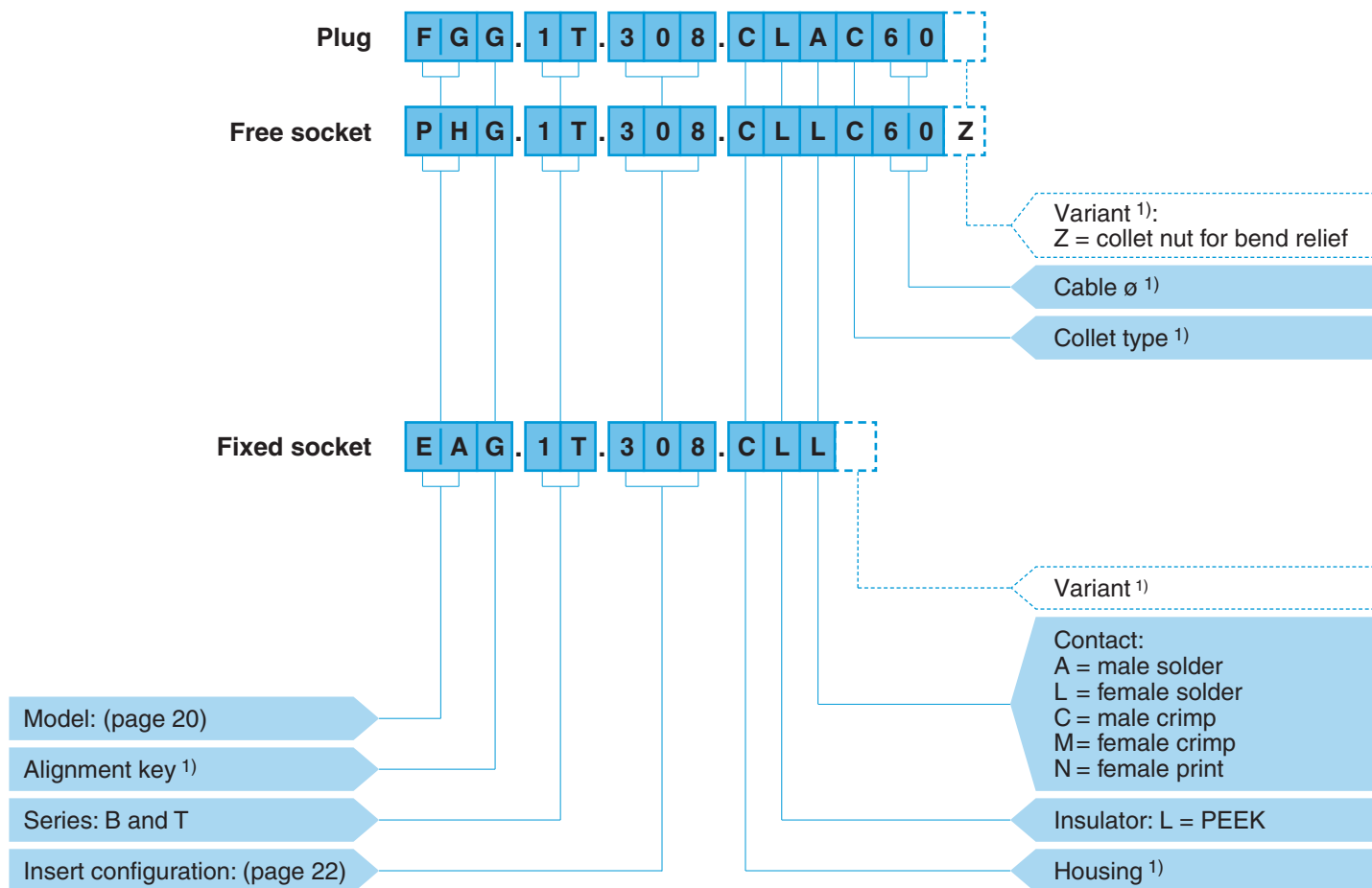

**FGG.1T.308.CLAC60** = straight plug with key (G) and cable collet, 1T Series, multipole type with 8 contacts, outer shell in chrome-plated brass, PEEK insulator, male solder contacts, C type collet for 6.0 mm diameter cable.

**PHG.1T.308.CLLC60Z** = free socket with key (G) and cable collet, 1T Series, multipole type with 8 contacts, outer shell in chrome-plated brass, PEEK insulator, female solder contacts, C type collet for 6.0 mm diameter cable and nut for fitting a bend relief.

**EAG.1T.308.CLL** = fixed socket, nut fixing, with key (G), 1T Series, multipole type with 8 contacts, outer shell in chrome-plated brass, PEEK insulator, female solder contacts.

**Note:** <sup>1)</sup> see Unipole-Multipole and T series catalogues for alternatives.

# Insert configuration

## Ethernet

Solder contacts		Reference	Series	Contact $\phi$ (mm)	Contact type			AWG			Solder contact		Crimp contact		Rated current (A) <sup>1)</sup>	
Crimp contacts					Solder	Crimp	Print (straight)	Solder (max.)	Crimp		Test voltage (kV DC) <sup>1)</sup> Contact-contact	Test voltage (kV DC) <sup>2)</sup> Contact-shell	Test voltage (kV DC) <sup>1)</sup> Contact-contact	Test voltage (kV DC) <sup>2)</sup> Contact-shell		
								min.	max.							
			308	1B-1T	0.7	●	●	●	22	32	22	0.67	0.81	0.92	0.92	5.0

**Note:** 1) see calculation method, caution and suggested standard on unipole-multipole catalogue.  
 2) test voltage (kV) contact-shell is slightly lower for T series (values here are for B series).

## PCB drilling pattern

### Fixed socket with straight print contact

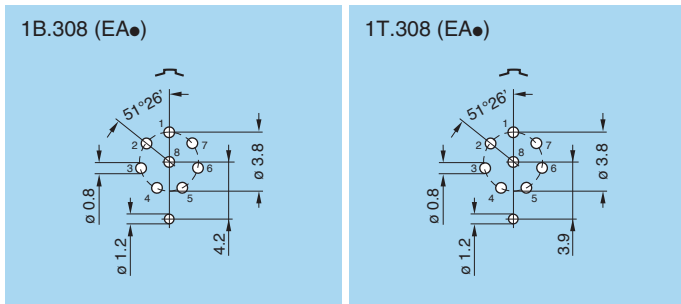

**Note:** contact numbering is for female contact version only.



# Ethernet 1000 Base-T4

(514)



These High-speed connectors meets Category 6 cable specifications (protocol IEEE 802.3an) up to 250 MHz for 1 Gigabit Ethernet transmission up to 100 m or 10 Gb/s up to 55 m. They are specifically designed to work in harsh environments, i.e. extreme temperatures, humidity and vibrations. The ratchet coupling M series offers a reliable solution in Defense applications such as data & ground forces tactical communications.

## 2M Series models

### Straight plugs

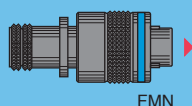

FMN

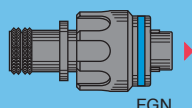

FGN

### Fixed socket

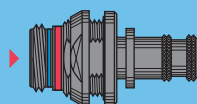

PEN

### Free sockets

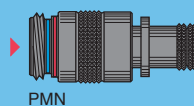

PMN

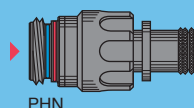

PHN

### Watertight fixed socket

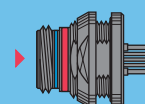

HEN

## Model Description

**FMN** Straight plug, key (N) with knurled grip and mold stop

**FGN** Straight plug, key (N) with arctic grip and mold stop

**HEN** Fixed socket, nut fixing, key (N), printed circuit, watertight (back panel mounting)

**PEN** Fixed socket, key (N) with mold stop (back panel mounting)

**PMN** Free socket, key (N) with knurled grip and mold stop

**PHN** Free socket, key (N) with arctic grip and mold stop

**Note:** for others models please reach out to LEMO. Print contact are highly recommended to limit risk of signal deterioration. See M series catalogue for connectors dimensions.

## Part Numbering System (2M series)

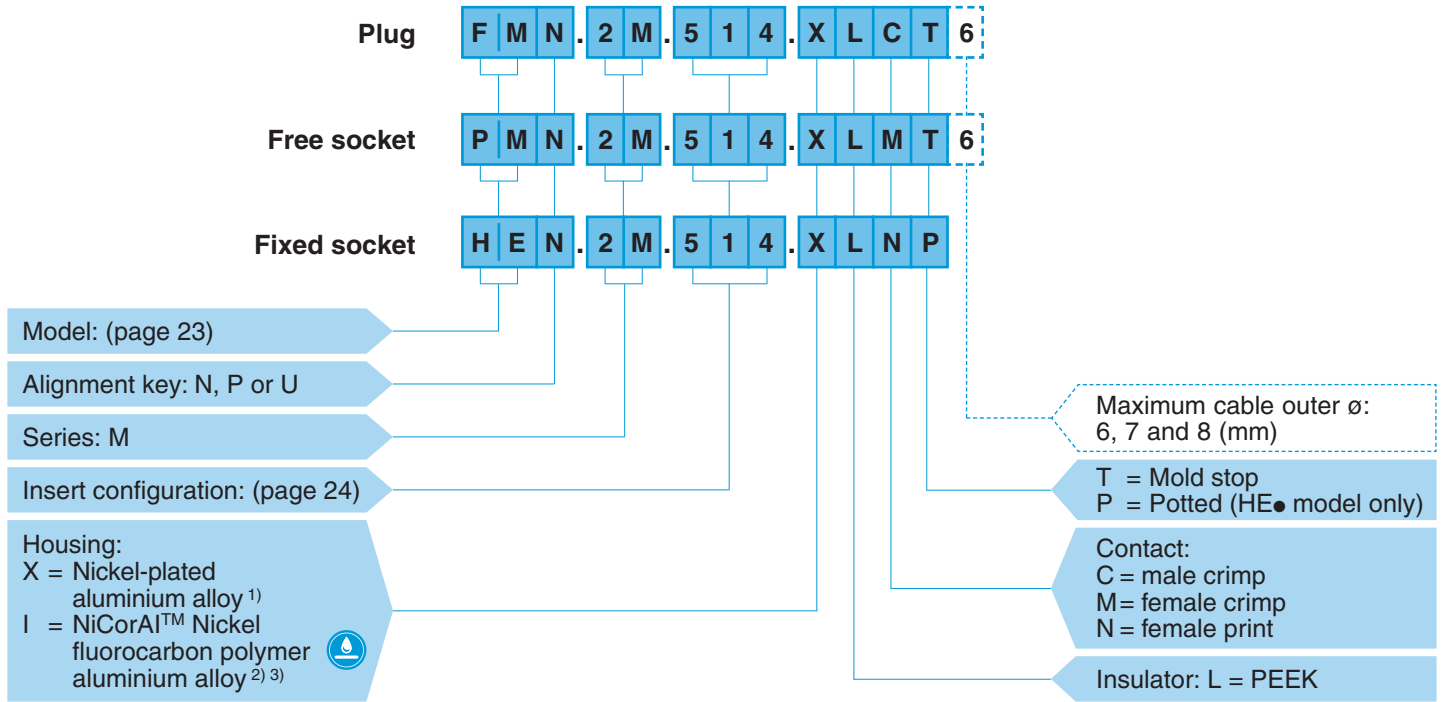

**FMN.2M.514.XLCT6** = straight plug with key (N), knurled grip, 2M series, multipole type with 8 contacts, outer shell in anthracite nickel-plated aluminium alloy, PEEK insulator, male crimp contacts.

**PMN.2M.514.XLMT6** = free socket with key (N), knurled grip, 2M series, multipole type with 8 contacts, outer shell in anthracite nickel-plated aluminium alloy, PEEK insulator, female crimp contacts and mold stop.

**HEN.2M.514.XLNP** = fixed socket, nut fixing, with key (N), 2M series, multipole type with 8 contacts, outer shell in anthracite nickel-plated aluminium alloy, PEEK insulator, female print contacts, watertight.

**Note:** <sup>1)</sup> anthracite colour / 48 hours salt fog resistance.  
<sup>2)</sup> anthracite colour / 500 hours salt fog resistance RoHS 2/REACH.  
<sup>3)</sup> NiCorAl™ nickel plating is not allowed with hermetic models.



## Ethernet

Male crimp contacts	Female crimp contacts	Reference	Series	Number of contacts	Contact $\varnothing$ (mm)	Crimp	Print	Test voltage (kV DC) Contact-contact	Test voltage (kV DC) Contact-shell	Rated current (A)
		514	2M	8	0.7	●	●	1.13	1.06	8

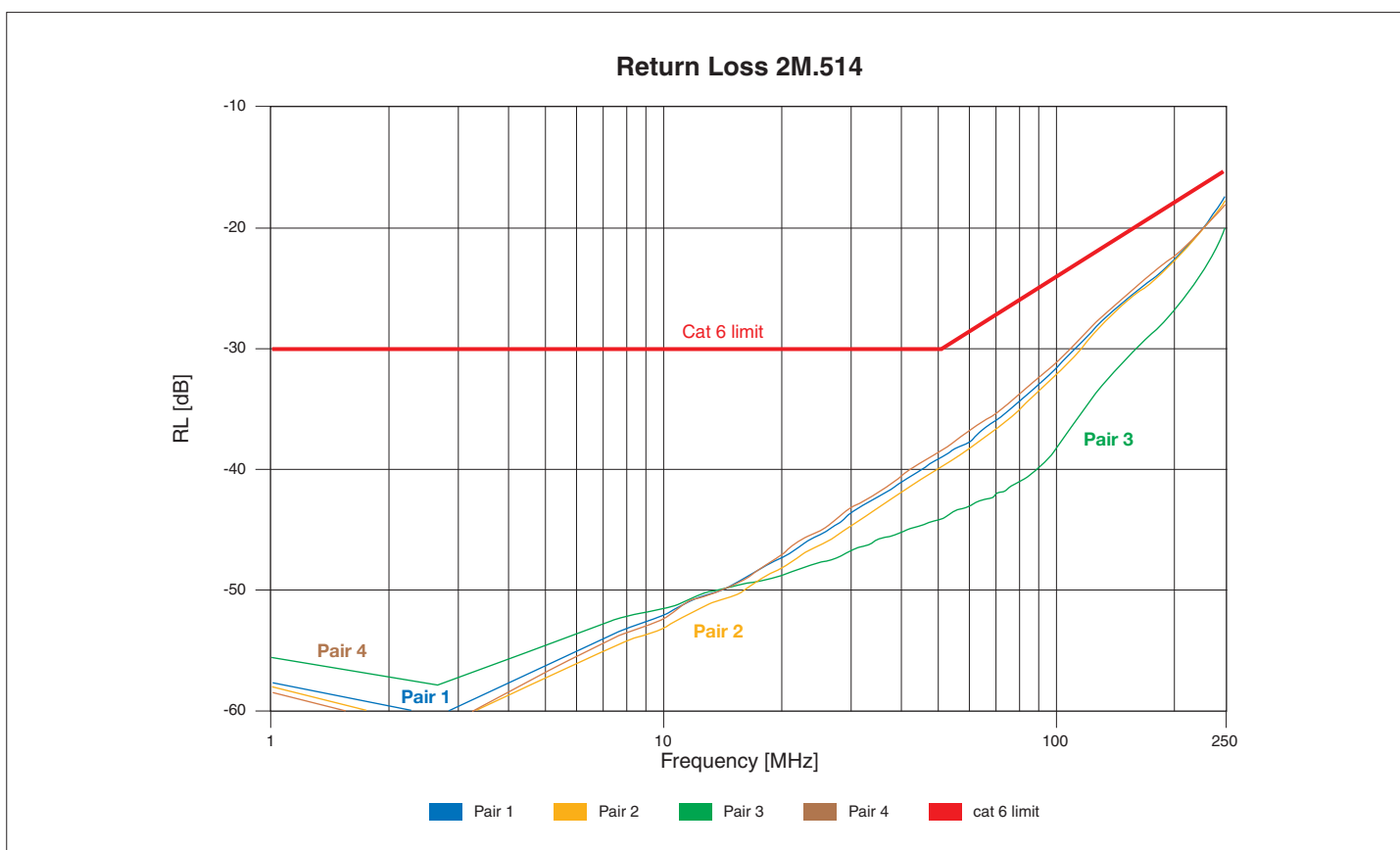
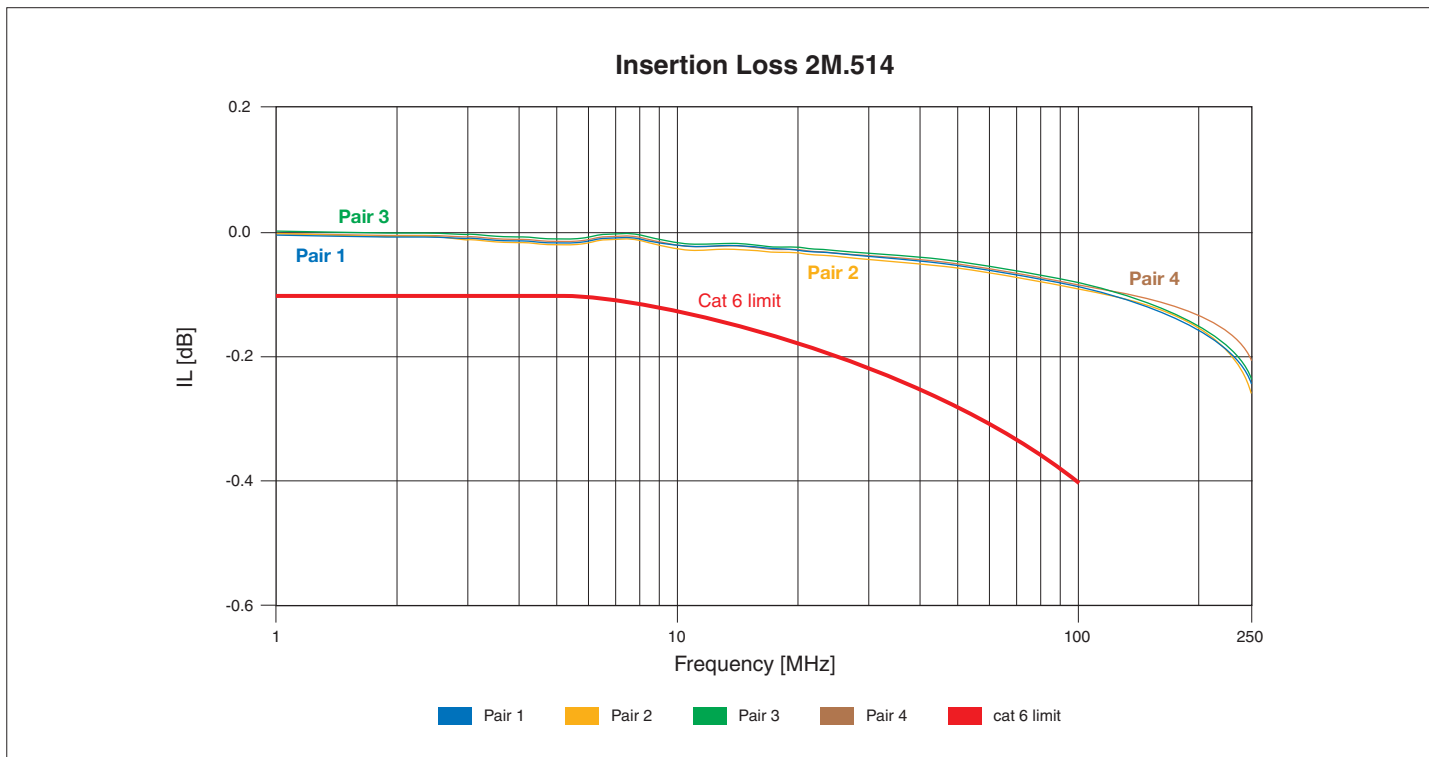

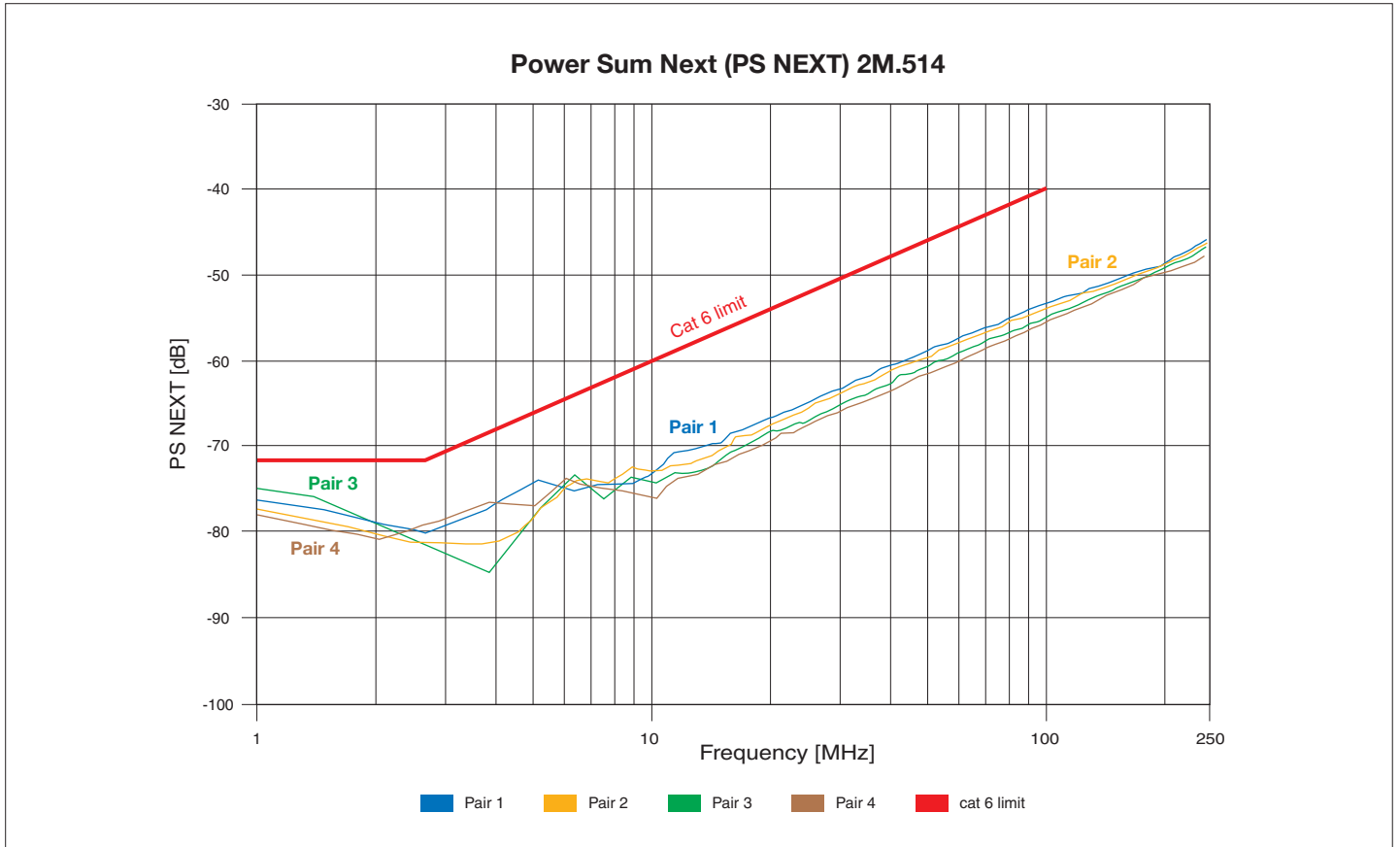

## PCB drilling pattern

### Fixed socket with straight print contact

2M.514 (HE●) (top view)

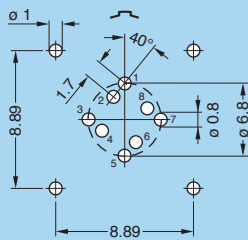

**Note:** contact numbering is for female contact version only.



(511)

# Ethernet 1000 Base-T1



(512)



## 1000 Base-T1 (SPE - 511)

The Ethernet 1000 Base-T1 protocol (IEEE 802.3bp standard), also better known as Single Pair Ethernet (SPE), allows high speed and bi-directional data traffic over light weight, single pair cable harnesses up to 1 Gb/s.

### 0B Series models

**Straight plugs**

**Fixed sockets**

**Free sockets**

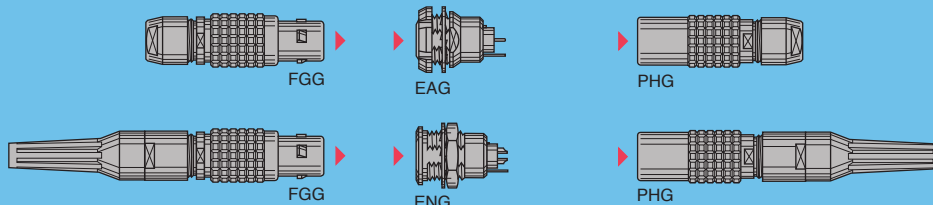

### 0T Series models

**Straight plugs**

**Fixed sockets**

**Free sockets**

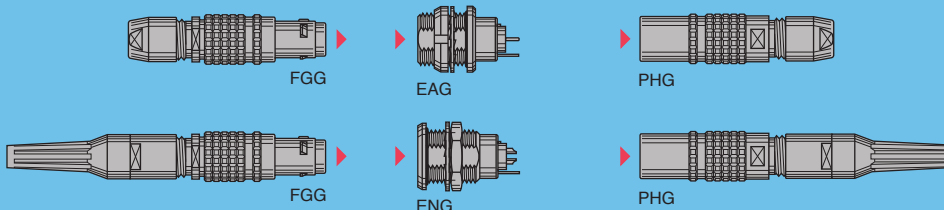

## 1000 Base-T1 (2 x SPE - 512)

The Ethernet 1000 Base-T1 protocol (IEEE 802.3bp standard), allows High-speed traffic over 2 pairs cable harnesses up to 1 Gb/s.

### 1B Series models

**Straight plugs**

**Fixed sockets**

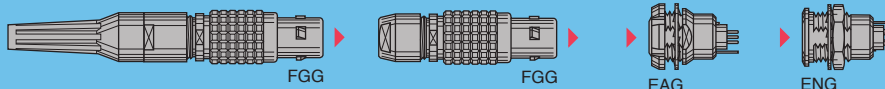

### 1T Series models

**Straight plugs**

**Fixed sockets**

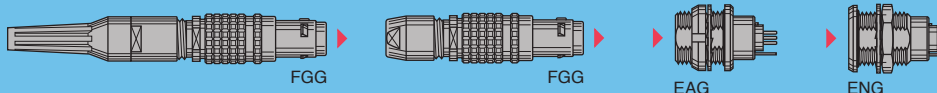

## Model Description

**EAG** Fixed socket with earthing tag, nut fixing, key (G) (back panel mounting)  
**ENG** Fixed socket with earthing tag, nut fixing, key (G)

**FGG** Straight plug, key (G), cable collet  
**FGG** Straight plug, key (G), cable collet and nut for fitting a bend relief

**PHG** Free socket, key (G), cable collet  
**PHG** Free socket, key (G), cable collet and nut for fitting a bend relief

**Note:** for others models please reach out to LEMO. Print contact are highly recommended to limit risk of signal deterioration. See Unipole-Multipole and T series catalogues for connectors dimensions.

## Part Numbering System (e.g. 0T series)

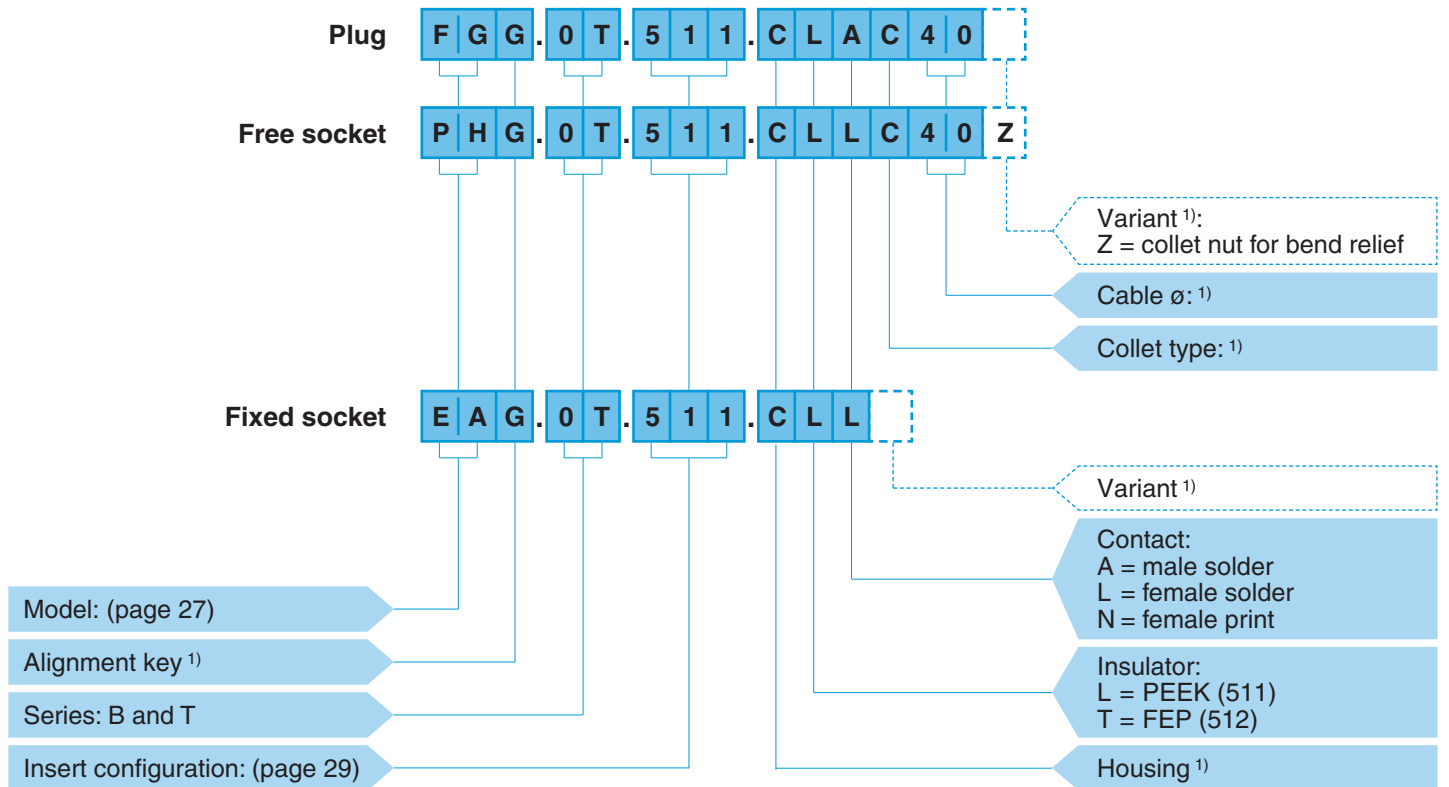

**FGG.0T.511.CTAC40** = straight plug with key (G) and cable collet, 0T Series, Ethernet type, outer shell in chrome-plated brass, PEEK insulator, male solder contacts, C type collet for 4.0 mm diameter cable.



**PHG.0T.511.CTLC40Z** = free socket with key (G) and cable collet, 0T Series, Ethernet type, outer shell in chrome-plated brass, PEEK insulator, female solder contacts, C type collet for 4.0 mm diameter cable and nut for fitting a bend relief.

**EAG.0T.511.CTL** = fixed socket, nut fixing, with key (G), 0T Series, Ethernet type, outer shell in chrome-plated brass, PEEK insulator, female solder contacts.

**Note:** <sup>1)</sup> see Unipole-Multipole and T series catalogues for alternatives.

## Insert configuration

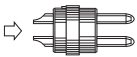
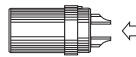
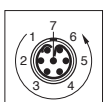
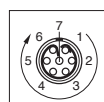
### Ethernet

Male solder contacts 	Female solder contacts 	Reference	Series	Number of contacts	Contact ø (mm)	Solder contact	Print contact	AWG			Test voltage (kV DC) contact-contact	Rated current (A) <sup>1)</sup>
								Wire section (mm <sup>2</sup> )		min.		
		511	0B-0T	2	0.5	●	●	0.14	30		26 <sup>1)</sup>	2.2
		512	1B-1T	7	0.5	●	●	0.14	30	26 <sup>1)</sup>	1.5	3

**Note:** <sup>1)</sup> see calculation method, caution and suggested standard on unipole-multipole catalogue.  
 AWG 26, please check wire construction, wire section should be less than 0.14 mm<sup>2</sup>.

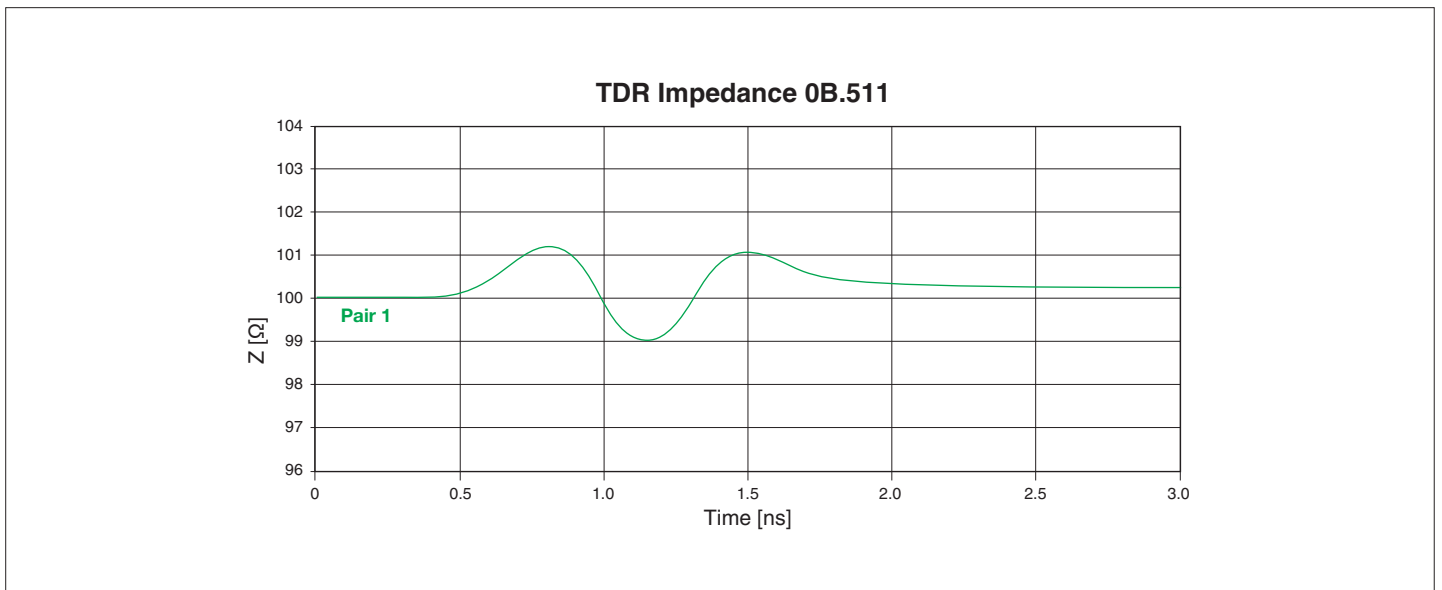
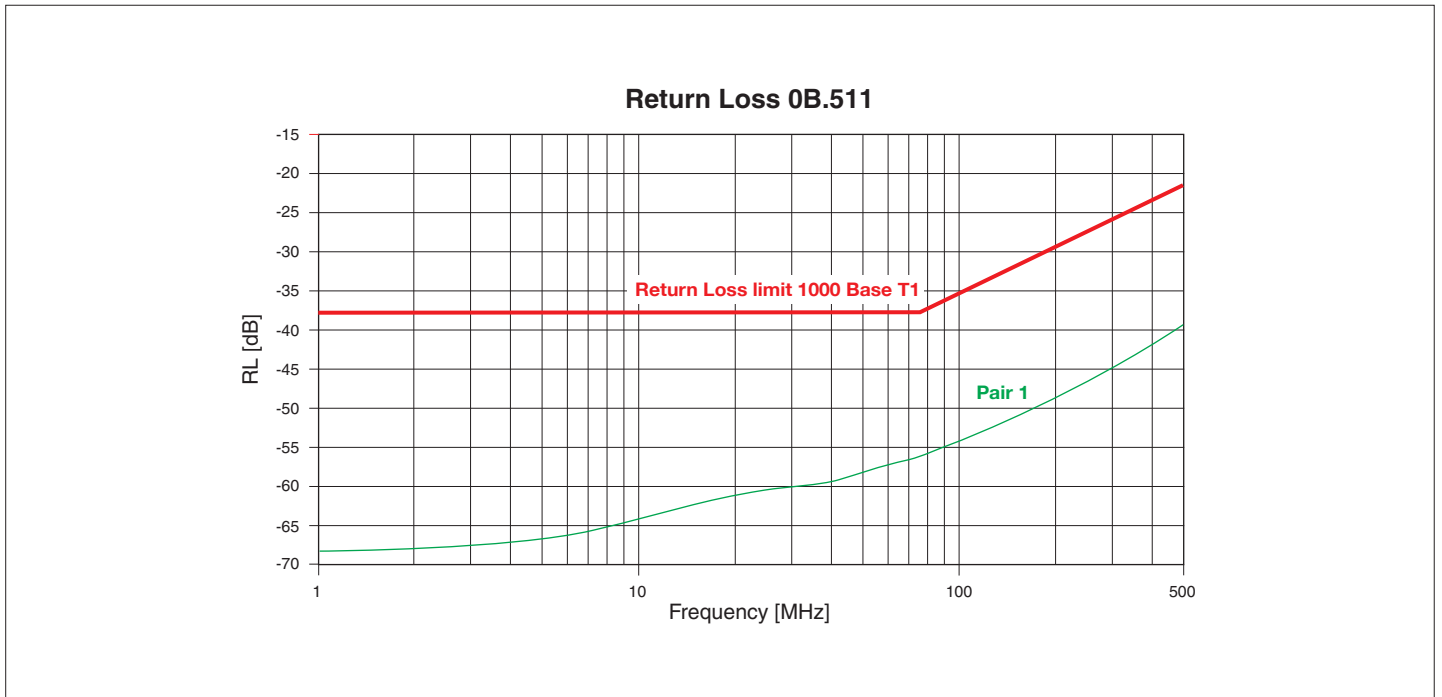
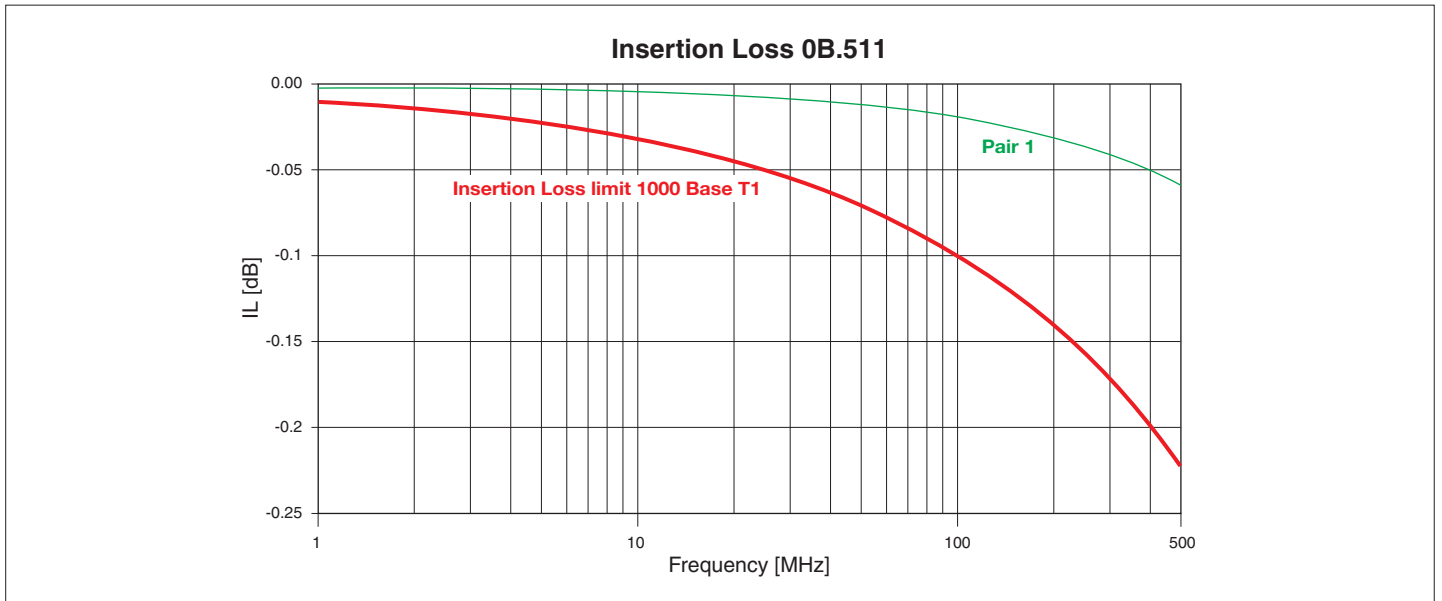



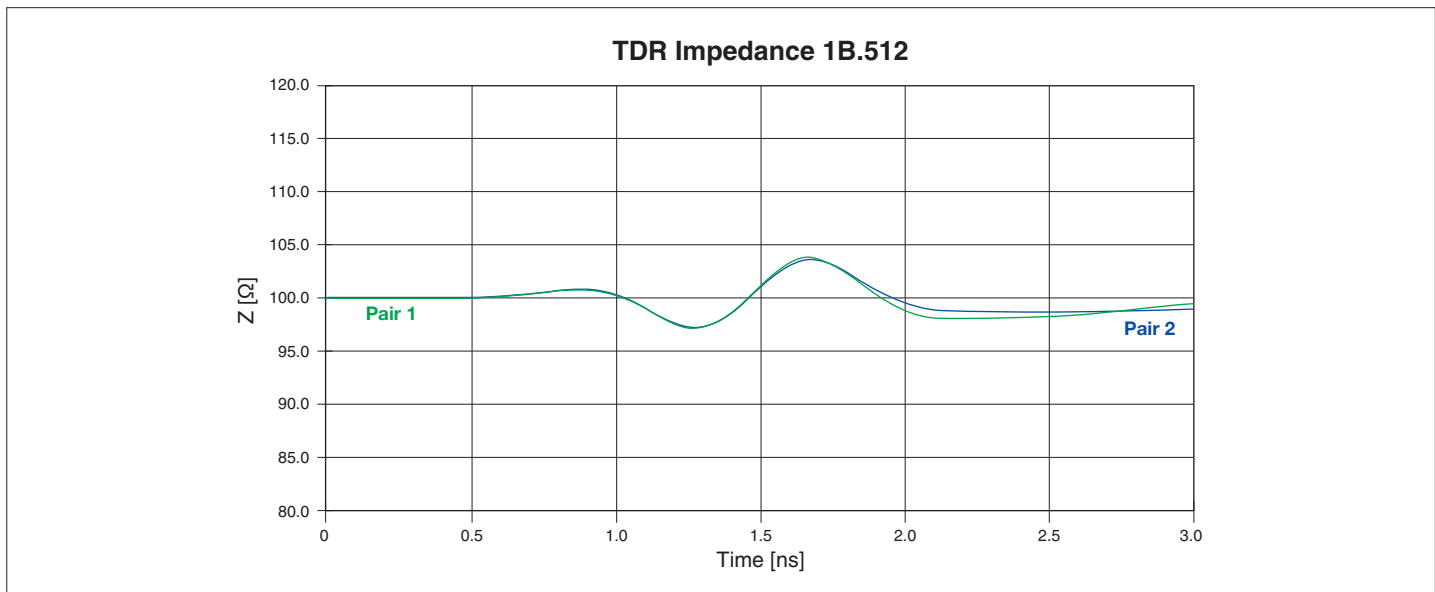
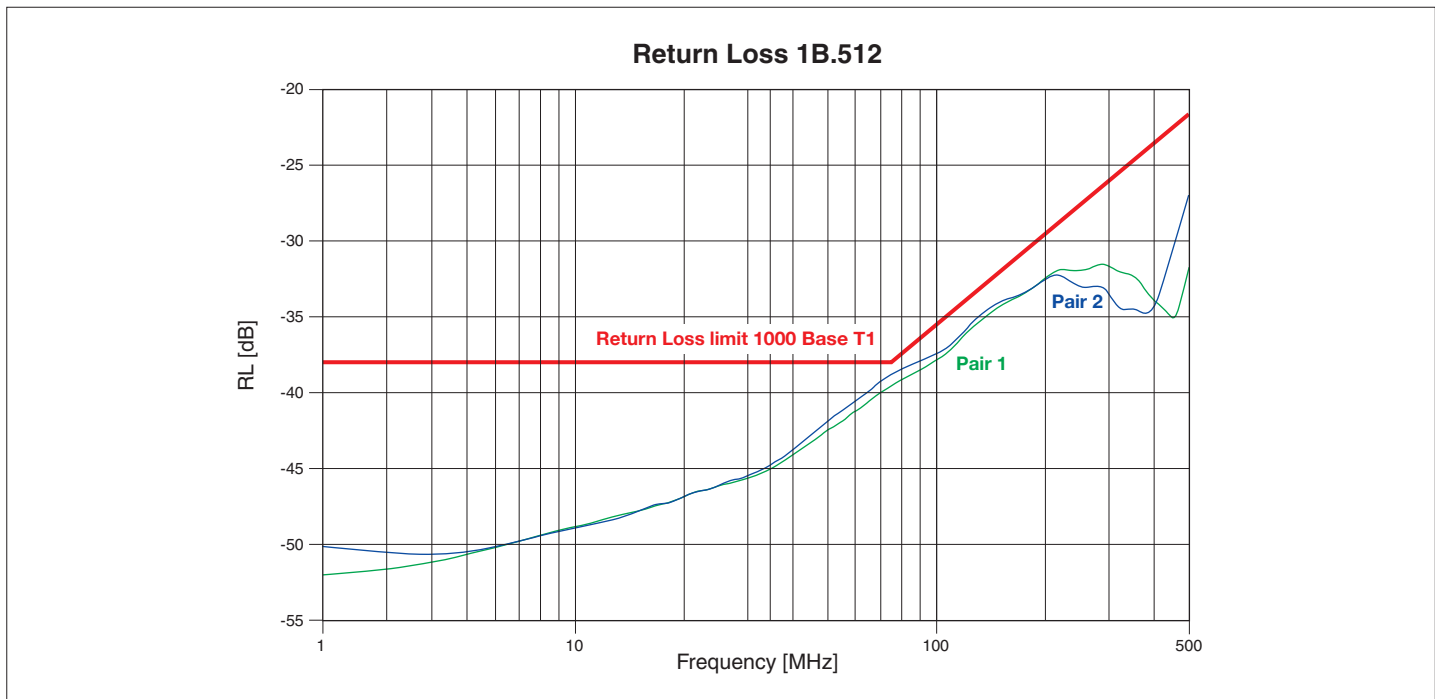
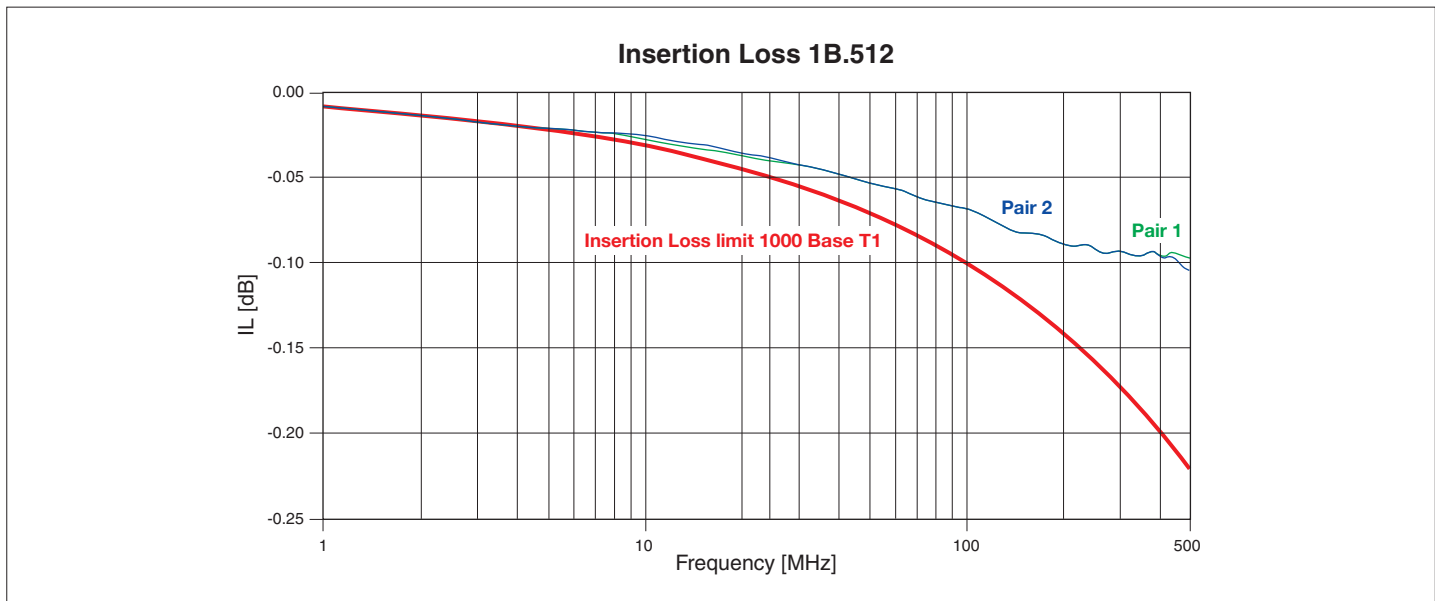

# PCB drilling pattern

## Fixed socket with straight print contact

0B.511 (EA●)

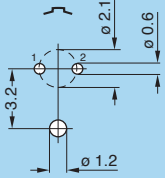

0T.511 (EA●)

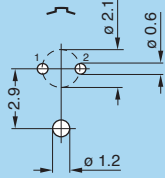

**Note:** contact numbering is for female contact version only.

1B.512 (EA●)

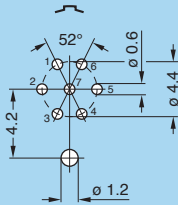

1T.512 (EA●)

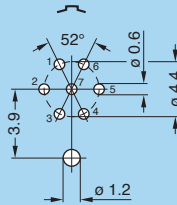

1B/1T.512

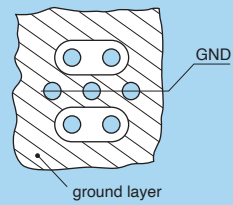

**Note:** contact numbering is for female contact version only.

## Product safety notice

**PLEASE READ AND FOLLOW ALL INSTRUCTIONS CAREFULLY AND CONSULT ALL RELEVANT NATIONAL AND INTERNATIONAL SAFETY REGULATIONS FOR YOUR APPLICATION. IMPROPER HANDLING, CABLE ASSEMBLY, OR WRONG USE OF CONNECTORS CAN RESULT IN HAZARDOUS SITUATIONS.**

### 1. SHOCK AND FIRE HAZARD

Incorrect wiring, the use of damaged components, presence of foreign objects (such as metal debris), and / or residue (such as cleaning fluids), can result in short circuits, overheating, and / or risk of electric shock. Mated components should never be disconnected while live as this may result in an exposed electric arc and local overheating, resulting in possible damage to components.

### 2. HANDLING

Connectors and their components should be visually inspected for damage prior to installation and assembly. Suspect components should be rejected or returned to the factory for verification. Connector assembly and installation should only be carried out by properly trained personnel. Proper tools must be used during installation and / or assembly in order to obtain safe and reliable performance.

### 3. USE

Connectors with exposed contacts should never be live (or on the current supply side of a circuit). Under general conditions voltages above 30 VAC and 42 VDC are considered hazardous and proper measures should be taken to eliminate all risk of transmission of such voltages to any exposed metal part of the connector.

### 4. TEST AND OPERATING VOLTAGES

The maximum admissible operating voltage depends upon the national or international standards in force for the application in question. Air and creepage distances impact the operating voltage; reference values are indicated in the catalog however these may be influenced by PC board design and / or wiring harnesses. The test voltage indicated in the catalog is 75% of the mean breakdown voltage; the test is applied at 500 V/s and the test duration is 1 minute.

### 5. CE MARKING

CE marking  means that the appliance or equipment bearing it complies with the protection requirements of one or several European safety directives.

CE marking  applies to complete products or equipment, **but not to electromechanical components, such as connectors.**

### 6. PRODUCT IMPROVEMENTS

The LEMO Group reserves the right to modify and improve to our products or specifications without providing prior notification.

### 7. **WARNING (Prop 65 State of California)**

Proposition 65 requires businesses to provide warnings to Californians about significant exposures to chemicals that cause cancer, birth defects or other reproductive harm. LEMO products are exempt from proposition 65 warnings because they are manufactured, marketed, and sold solely for commercial and industrial use. For further information, please visit <https://www.lemo.com/quality/LEMO-Prop-65-compliance-declaration.pdf>.

## Disclaimers

LEMO works constantly to improve the quality of its products; the information and illustrations figuring in this document may therefore vary and are not binding. In any case, LEMO makes no specific warranty of merchantability, fitness for a particular purpose, third party components as such or included in assembly, non-infringement, title, accuracy, completeness, or security. The user is fully responsible for his products and applications using LEMO component.

In no event shall LEMO, its affiliates, officers, agents or employees be liable for any incidental, indirect, special or consequential damages in connection with the products or services provided by LEMO, including (without limitation) loss of profits or revenues, interruption of business, loss of use of the products or any associated equipment, materials, components or products, damages to associated equipment or in combination with other components, materials.

Reproduction of significant portions of LEMO information in LEMO data books or data sheets is permissible only if reproduction is without alteration and is accompanied by all associated warranties, conditions, limitations, and notices. LEMO is not responsible or liable for such altered documentation. Information of third parties may be subject to additional restrictions.



## HEADQUARTERS

### SWITZERLAND

LEMO SA  
Tel: +41 21 695 16 00  
info@lemo.com

## SUBSIDIARIES

### AUSTRIA

LEMO ELEKTRONIK GESMBH  
Tel: +43 1 914 23 20 0  
salesAT@lemo.com

### BRAZIL

LEMO LATIN AMERICA LTDA  
Tel: +55 11 94242 4293  
info-la@lemo.com

### CANADA

LEMO CANADA INC  
Tel: +1 905 889 56 78  
info-canada@lemo.com

### CHINA / HONG KONG

LEMO ELECTRONICS  
(SHANGHAI) CO., LTD  
Tel: +86 21 5899 7721  
cn.sales@lemo.com

### DENMARK

LEMO DENMARK A/S  
Tel: +45 45 20 44 00  
info-dk@lemo.com

### FRANCE

LEMO FRANCE SÀRL  
Tel: +33 1 60 94 60 94  
info-fr@lemo.com

### GERMANY

LEMO ELEKTRONIK GMBH  
Tel: +49 89 42 77 03  
info@lemo.de

### HUNGARY

REDEL ELEKTRONIKA KFT  
Tel: +36 1 421 47 10  
info-hu@lemo.com

### ITALY

LEMO ITALIA SRL  
Tel: +39 02 66 71 10 46  
sales.it@lemo.com

### JAPAN

LEMO JAPAN LTD  
Tel: +81 3 54 46 55 10  
info-jp@lemo.com

### NETHERLANDS / BELGIUM

LEMO CONNECTORS  
NEDERLAND B.V.  
Tel: +31 232 06 07 01  
info-nl@lemo.com

### NORWAY / ICELAND

LEMO NORWAY A/S  
Tel: +47 22 91 70 40  
info-no@lemo.com

### SINGAPORE

LEMO ASIA PTE LTD  
Tel: +65 6476 0672  
sg.sales@lemo.com

### SPAIN / PORTUGAL

IBERLEMO SAU  
Tel: +34 93 860 44 20  
info-es@lemo.com

### SWEDEN / FINLAND

LEMO NORDIC AB  
Tel: +46 8 635 60 60  
info-se@lemo.com

### SWITZERLAND

LEMO VERKAUF AG  
Tel: +41 41 790 49 40  
ch.sales@lemo.com

### UNITED ARAB EMIRATES

LEMO MIDDLE EAST  
CONNECTORS LLC  
Tel: +971 55 222 36 77  
info-me@lemo.com

### UNITED KINGDOM

LEMO UK LTD  
Tel: +44 1903 23 45 43  
lemouk@lemo.com

### USA

LEMO USA INC  
Tel: +1 707 578 88 11  
info-us@lemo.com

### USA

NORTHWIRE INC  
Tel: +1 715 294 21 21  
cableinfo\_northwire@lemo.com

## DISTRIBUTORS

ARGENTINA  
AUSTRALIA  
BRAZIL  
CHILE

COLOMBIA / PERU  
CZECH REPUBLIC  
GREECE  
INDIA

ISRAEL  
NEW ZEALAND  
POLAND  
SOUTH AFRICA

SOUTH KOREA  
TURKEY  
UKRAINE

CATALOG ONLINE



WWW.LEMO.COM